

PRODUCT  
CATALOGUE  
2025



**VIALLI** GERMANY   
**GmbH**  
Product Catalogue



# TABLE OF CONTENTS

<b>OVERVIEW</b>	2
■ VIALLI GMBH: A SUCCESS STORY	2
<b>SYSTEM CHARACTERISTICS &amp; TECHNICAL SPECIFICATION</b>	3
■ System Characteristics	3
■ Laboratory Operations & Test Devices	4
■ Technical Specifications	6
■ Consistency Properties	8
■ Expansion	10
■ Bearing Distance	12
■ Pressure Drops	13
■ Resistance Coefficient Values	24
■ Quality Considerations	25
<b>VIALLI FIBER GLASS REINFORCED PIPE</b>	27
<b>VIALLI ALUMINUM REINFORCED PIPE</b>	28
<b>VIALLI PP-RCT PIPES</b>	29
■ PP-RCT Advantages	31
■ PP-RCT Properties	32
■ Material Strength & Resistance	33
■ Types of PP-RCT Pipes	35
■ PP-RCT Thermal Liners Expansion	36
■ Installation Recommendations	38
■ Chemical Resistance	41
■ Heat Loss Gain	43
■ Insulation	44
■ Flow Rate vs. Velocity	45
<b>FITTINGS WITH METAL INSERTS</b>	46
<b>WELDING</b>	47
■ Types of Welding	47
■ Socket Welding	48
■ Electrofusion Welding	49
<b>VIALLI PRODUCTS</b>	52
■ PPR Pipes	53
■ PP-RCT Pipes	57
■ VIALLI Fittings	60
■ Electrofusion Fittings	70
■ Tools and Equipment	73
<b>FREQUENTLY ASKED QUESTIONS</b>	76
<b>TECHNICAL SUPPORT &amp; CONTACTS</b>	81

## VIALLI GmbH Germany Pipes & Fittings

**VIALLI**, a renowned German brand specializing in plastic piping systems, is proudly manufactured by **VIALLI GmbH**. With over 15 years of experience, we have consistently delivered top-quality products utilizing cutting-edge German Technology that adheres to DIN standards, utilizing only the highest quality materials.

Our commitment to excellence extends beyond borders as we export our products to Europe, various parts of Asia, and the Middle East. Our overarching vision is to broaden our reach and make this exceptional product accessible to as many regions as possible.

### **Our comprehensive range of products includes:**

**VIALLI PP-Rc** Pipes & Fittings, meticulously crafted in accordance with German DIN 8077 and DIN 8078 Standards. Our lineup includes PP-Rc Stabi pipes with an aluminum layer and PP-Rc Fiberglass Composite Pipes.

**VIALLI PP-RCT Pipes & Fittings**, similar to our standard PP-Rc offerings, our PP-RCT Pipes and Fittings meet the stringent requirements of German DIN 8077 and DIN 8078 Standards. This range also encompasses PP-Rc Stabi pipes with an aluminum layer and PP-Rc Fiberglass Composite Pipes.

**VIALLI PEXa** pipe & fittings products are engineered to meet the rigorous German standards of DIN 16892 and DIN 16893, ensuring the required Cross-link Degree for optimal performance.

At **VIALLI**, we prioritize the highest hygienic and quality standards. For more details and to explore our complete product catalogue, make sure to visit our website. Your satisfaction is our priority, and we look forward to serving you with excellence.

All of our products have undergone rigorous testing to ensure they meet the stringent Hygienic and Quality Test Requirements recommended by WRAS.



## SYSTEM CHARACTERISTICS AND BENEFITS

---

1. Plastic piping for interior hot and cold water distribution systems in buildings, floor & Central Heating Systems.
2. Meeting all health requirements.
3. No corrosion and/or encrustation.
4. Exceptionally long service life while preserving high utility value.
5. Trouble-Free operations with less noise.
6. Less friction losses than with traditional materials.
7. Less weight compared to traditional materials.
8. Quick, easy and clean installation works.
9. Resistance in aggressive environments.

## ENVIRONMENTAL ASPECTS

---

Fully recyclable product; neither toxic nor otherwise harmful substances are used in its manufacture and/or application.

## INTENDED USE

---

It is intended for interior hot and cold water distribution systems in buildings and floor & central heating systems:

**PN 10**-Cold water distribution and floor heating systems

**PN 16**-Higher Pressure cold water distribution and DHW Systems at lower Pressures

**PN 20**-Hot water distribution systems, Central Heating

**PN 25**-Hot water distribution systems, Central Heating

## TECHNICAL SPECIFICATIONS

---

**Material** – statistical polypropylene copolymer (random – copolymer) for injection molding and extrusion processes with excellent welding ability; nickel – plated brass fittings.

**Manufacturing process** – pipes are produced by extrusion, while fittings by injection molding.

**Pipe lengths** – 4 Meters.

**Assembly/Fixing** – the product range covers all needs for interior water distribution systems and heating system routes.

**Transitions for other pipe materials** – implemented by threaded connection (i.e. by combined couplings) or flange connections.

**Coupling** – standard method is polyfusion welding or by electrofusion.

**Surface finish** – elements are in green color without any finish, separate metal element brass, alternatively, nickel plated, black identification printing on the surface.

## PHYSICAL CHEMICAL PROPERTIES

---

**Density:** between 0.895 to 0.93 Kg/m<sup>3</sup>

**Thermal expansion coefficient:** for VIALLI PP-Rc pipes 0.15mm/Mk

**Thermal conductivity:** 0.22 W/Mk, fire rating-Class C3

**Resistance against Chemicals:** PP-Rc piping systems are intended mainly for water distribution (drinking, cold, hot, irrigation, etc.) – it is also possible to use the system for other media, in which in case their concrete use is governed by DIN 8078 Bb-1 possible to consult the manufacturer.

## LABORATORY OPERATION & TEST DEVICES

---

1. MFI (Melt Flow Index) Test Device
2. Precise Balance
3. IZOD-Charpy test Device
4. Pulling–Pressing Test Device
5. Hallow Die Punch (Sampling Device)
6. Shore (Hardness Device)
7. Microtome Device
8. Microscope Image System
9. Furnace-Deep Freezer
10. Furnace
11. Pressure Test
12. Momentum Strength Test

### 1. MFI (Melt Flow Index) Test Device:

This device is used in simulating the material's flow behavior before being processed in the extruder. This device gives us information regarding the flow rate of the material in the unit temperature and time, this helps us to have information on the possible behavior of the material in the extruder. The quality Standard for this test is ISO 1133.

### 2. Precise Balance:

Using this balance, the weight of the material which was passed from MFI device is determined according to standard ISO 1183 separately in the air and in the liquid whose density is known. After having these weight figures, the material's density is determined by using the specific density formula.

### 3. IZOD-Charpy test Device:

With this device, the amount of the energy absorption and the possible applicable force on the unit area are determined by using free falling method using materials having different weights. By doing this test, we obtain information regarding material's behavior at the different loads with sudden impacts. The standards applied for this test are TS 1004, TS 1005, ISO 179 and ISO 180.

#### **4. Pulling–Pressing Test Device:**

Using this device, we obtain information's about the maximum load strength, elasticity module (the maximum force strength per unit area) maximum tension. Elongation in percentage, deformation, elongation at break point, tension at break point etc. of the product. By means of these test we can make forecasts on the possible behavior of the material in the working conditions. In these test, ISO R 527 standard is applied.

#### **5. Hallow Die Punch (Sampling Device):**

This device is used for the preparation of the sample which will be tested in the pulling test device. The sample is prepared in accordance with Standard No. ISO 527.

#### **6. Shore (Hardness Device):**

This device is used to determine the material's hardness. When we apply load on the sample, if the material is too soft then it will be pressed like paper, while if it is too hard then deformation will occur. For this reason, the hardness value of the product must be within the range of the values mention in the Standard No. DIN 53505.

#### **7. Microtome Device:**

This is a device used to cut small pieces which can be monitored under microscope for the purpose of inspecting the infrastructure of the material.

#### **8. Microscope Image System:**

This is a system used for monitoring the fibrous structure of the material. The aim of this test is to ensure that the material has a homogeneous infrastructure. If the fibrous image is not consistent, it indicates that there may be an issue either in the production stage or with the quality of the raw material itself.

#### **9. Furnace-Deep Freezer:**

These devices are used for rapid cooling or heating through shock testing. At specific intervals of time, an impact test is applied to the material held in the furnace or deep freezer, and its behavior is monitored at different test temperatures.

#### **10. Furnace:**

This device is used for thermal strength testing. The purpose of this test is to monitor whether the length of the material exceeds more than 3% when subjected to a specific temperature for a certain period. This test is important because at considerably higher temperatures, the material expands and elongates, while at lower temperatures, it contracts. However, after exposure to higher or lower temperatures, the material does not fully return to its normal size at normal temperatures. This characteristic leads to a change from a round shape to an oval shape in a closed pipe system. The standard applied for this test is TS 5450.

#### **11. Pressure Test:**

For the pipes produced according to the standard TS 5439, to monitor the strength of the pipes when subjected to pressure, a pressure test is administered under 100h (at 20 °C), and 165 and 1000h (at 80 °C). the standards used for this test are ISO 4427 (for PE 100), ISO 4437 (for 80) and TSE 10827.

#### **12. Momentum Strength Test:**

In addition to the leak test, a strength test is applied with the aim of testing the harmonical work of the metal fittings with plastic. In order to be able to apply a 95 °C temperature to the pipe it must resist 10 Bar pressure for short time test.

## 1. Mechanical Properties:

Property	Measuring Technique	Unit	Value
Coefficient of viscosity J. Average molar Weight	ISO 1191 Solvent viscosity C= 0.001 g/cm <sup>3</sup>	Cm <sup>3</sup> /g	400
Melting index MFI 190/5 MFI 230/s	ISO / R1133 Procedure 5 Procedure 14	g/10 min g/10 min	0.5 1.5
Density	SO/ R1183	g/cm <sup>3</sup>	0.895
Melting range	Polarizing microscope	°C	140-150
Double voltage Ultimate tensile strength Expansion to at tear	ISO / R527 Char Speed D Test bar Fig. 2	N/mm <sup>2</sup> N/mm <sup>2</sup> %	21 40 800
Ball – pressure Hardness	ISO 2039 (H 358/30)	N/mm <sup>2</sup>	40
Bending stress at 3.5% Edge Fiber expansion	ISO 178 Test Specimen 5.1	N/mm <sup>2</sup>	20
Modulus of elasticity	ISO 178	N/mm <sup>2</sup>	800
Modulus of transverse elasticity -10° C 0° C 10° C 20° C 30° C 40° C 50° C 60° C	ISO / R537 Method A	N/mm <sup>2</sup> N/mm <sup>2</sup> N/mm <sup>2</sup> N/mm <sup>2</sup> N/mm <sup>2</sup> N/mm <sup>2</sup> N/mm <sup>2</sup> N/mm <sup>2</sup> N/mm <sup>2</sup>	1,100 770 500 370 300 240 180 140
Tensile properties further to impact bending test at 0°C	DIN 8078		No Fracture
Impact Strength (according to Charpy) RT 0°C -10°C	ISO /R179 Test bar in conformity with fig. 2	mJ/mm <sup>2</sup> mJ/mm <sup>2</sup> mJ/mm <sup>2</sup>	No Fracture No Fracture

## TECHNICAL SPECIFICATION

Allowable operating pressure for PP-Rc pipes conveying water, safety factor (SF) = 1.5

Temperature °C	Years of Service	Standard dimension ratio SDR		
		9	7.4	6
10	1	22.1	27.8	35.1
	5	20.8	26.2	33.0
	10	20.3	25.6	32.2
	25	19.6	24.7	31.1
	50	19.1	24.1	30.3
	100	18.5	23.5	29.6
20	1	18.8	23.7	29.9
	5	17.7	22.3	28.1
	10	17.2	21.7	27.4
	25	16.6	21.0	26.4
	50	16.2	20.4	25.7
	100	15.8	19.9	25.0
30	1	16.0	20.2	25.4
	5	15.0	18.9	23.8
	10	14.6	18.4	23.2
	25	14.1	17.7	22.3
	50	13.7	17.2	21.7
	100	13.3	16.8	21.1
40	1	13.6	17.1	21.6
	5	12.7	16.0	20.2
	10	12.3	15.5	19.6
	25	11.9	15.0	18.8
	50	11.5	14.5	18.3
	100	11.2	14.1	17.8
50	1	11.5	14.5	18.2
	5	10.7	13.5	17.0
	10	10.4	13.1	16.5
	25	10.0	12.6	15.9
	50	9.7	12.2	15.4
	100	9.4	11.8	14.9
60	1	9.7	12.2	15.4
	5	9.0	11.3	14.3
	10	8.7	11.0	13.9
	25	8.4	10.5	13.3
	50	8.1	10.2	12.9
70	1	8.1	10.3	12.9
	5	7.5	9.5	12.0
	10	7.3	9.2	11.6
	25	6.3	8.0	10.0
	50	5.3	6.7	8.5
80	1	6.8	8.6	10.8
	5	6.0	7.6	9.6
	10	5.1	6.4	8.1
	25	4.1	5.1	6.5
95	1	4.8	6.1	7.6
	5	3.2	4.1	5.2
	(10) <sup>a</sup>	(2.7)	(3.4)	(4.3)



## Consistency Properties

### Consistency Properties PN 20

From the requirements of the temperature/pressure ratio in accordance with DIN 1988 T2 and the long term durability properties in accordance with DIN 16962 and DVS 2207, the Green pipes with a pressure degree PN20 meets the specified safety correction value of Safety Factor = 1.5

In accordance with DIN 1988 T2, the following requirements are stipulated as regards service on drinking water pipe systems.

**Table 2:** Shows the admissible operation pressure depending on the temperature with a maximum number of years of operation for the transfer of water.

**Table 1:** Operation requirements for pipes

	Operational Excess pressure bar	Temp °C	Hours p.a h
Cold water	0 to 10 Fluctuating	To 25	8760
Hot Water	0 to 10 Fluctuating	Up 60 Up to 85	8760 50

**Table 2:** Admissible operational pressure

Temp. (°C)	Max. OP. (years)	Adm. Pressure
10	50	29.3
20	50	25.9
30	50	22.1
40	50	18.4
50	50	14.7
60	50	10.9
70	50	8.0
80	50	6.5
95	50	5.2

### Consistency Properties PN 25

With regard to the demands of the temperature/pressure ratio in accordance with DIN 1988 T2 and long-term durability properties in accordance with DIN 16962 & DVS 2207. The VIALLI pipe with pressure degree PN25 meets the specified safety correction value of safety Factor=1.5

**Table 4:** Shows the admissible operation pressure depending on the temperature for the flow media, taking into account a maximum number of years of operation.

**Table 3:** Operation requirements for pipes

	Operational Excess pressure bar	Temp °C	Hours p.a h
Cold water	0 to 10 Fluctuating	To 25	8760
Hot Water	0 to 10 Fluctuating	Up 60 Up to 85	8030 730

**Table 4:** Admissible operational pressure

Temp. (°C)	Max. OP. (years)	Adm. Pressure
10	50	36.7
20	50	32.3
30	50	27.7
40	50	23.0
50	50	18.3
60	50	13.7
70	50	10.0
80	50	8.1
95	50	6.5

# Behavior Under Long Term Stress

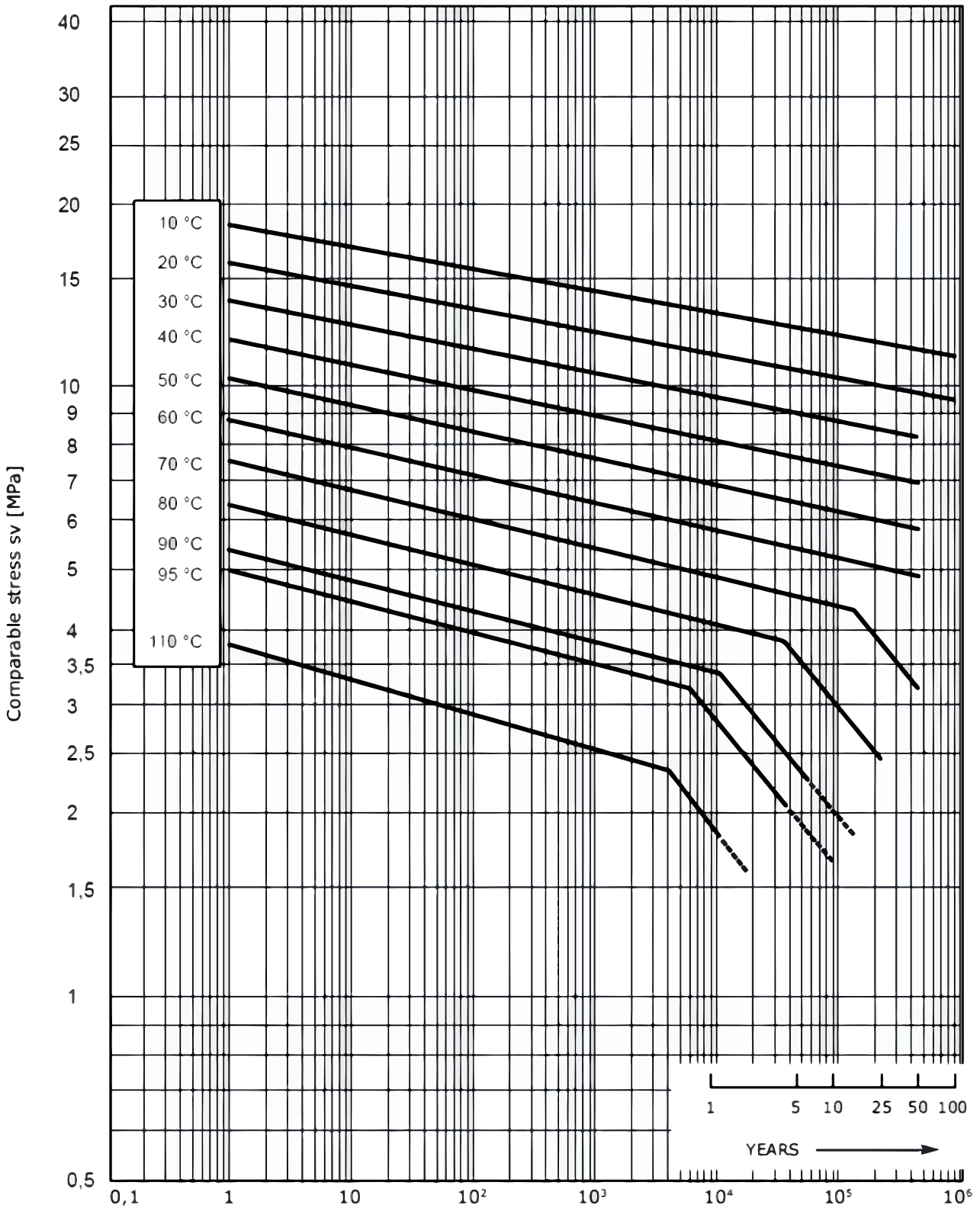

Service Life in Hours

Termination of an isotherm indicates maximum service life also at lower tension.

## Linear Expansion

The following items need to be taken into consideration when calculating modifications in length

- Ambient and materials temperature upon installation
- Temperature difference between lowest and highest pipe wall temperatures
- Expansion coefficient

Below the formula for the calculation of length alteration :  $\Delta L = \alpha \times L \times \Delta T$

$\Delta L$  = length alternation in mm  
 $\alpha$  = Expansion coefficient in K-1  
 polypropylene pipes  $\alpha = 0.15$   
 prostab AL/PPR composite pipes  
 $\alpha = 0.05$   
 $L$  = pipe length in mm  
 $\Delta T$  = Difference in temperature in K

### Example

Pipe length	Temperature range	
	Pipe wall temperature	60°C
	Temp. at installation	15°C
		45K

## Expansion

The alteration of length may be compensated by means of extensions loops, bending legs, extension bows or appropriate adapters.

FP = Fixing Point  
 LS = length of bending Pipe  
 SP = Sliding Point  
 $\Delta L = \Delta L_1 + \Delta L_2$

The minimum length of the bending leg results from:

$$L_s = K \cdot \sqrt{d \cdot \Delta L}$$

### Expansion:

$L_s$  = length of bending leg in mm  
 $K$  = Constant depending on material  
 (K value for PP= 15)  
 $d$  = pipe diameter in mm  
 $\Delta$  = Elongation in mm, calculated by equation  $\Delta L = \alpha \cdot L \cdot \Delta T$

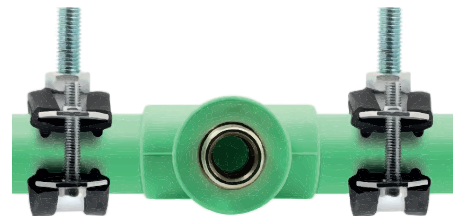
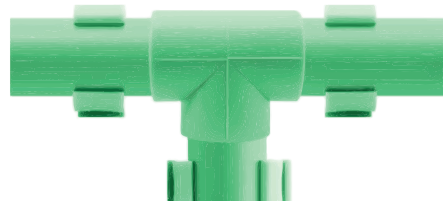

Example of graphic and mathematical determination of bending

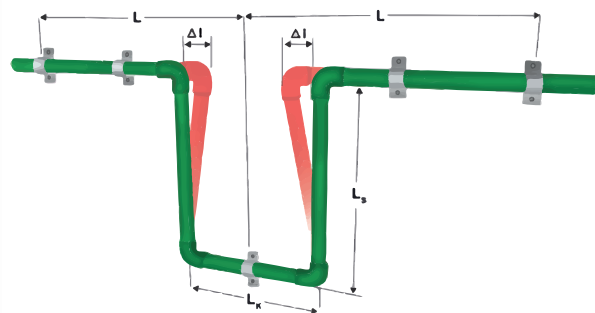
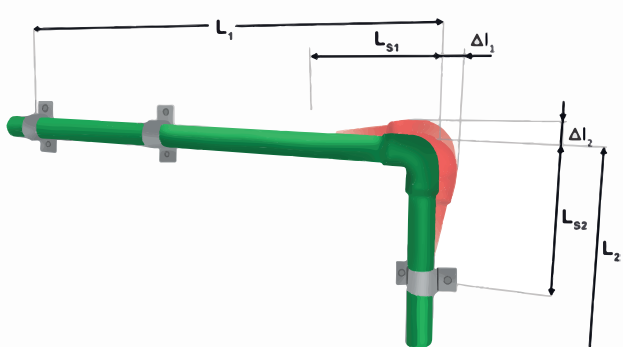

### Example 1

To be Established:

Minimum bending leg for a **VIALLI pipe**  
 $\varnothing=40$ , pipe Length 6m,  
 $\Delta T= 50$  K

1. Expansion  
 $\Delta L= 0.15 \times 6 \times 50 = 45$  mm

2. Minimum bending Leg Length:  
 $L_s =$   
 $15 \sqrt{40 \times 45} = 636$  mm

### Example 2

To be Established:

Minimum bending leg for a **VIALLI pipe**

1. Expansion  
 $\Delta L= 0.05 \times 5 \times 50 = 15$  mm

2. Minimum bending Leg Length:  
 $L_s =$   
 $15 \sqrt{40 \times 15} = 367$  mm

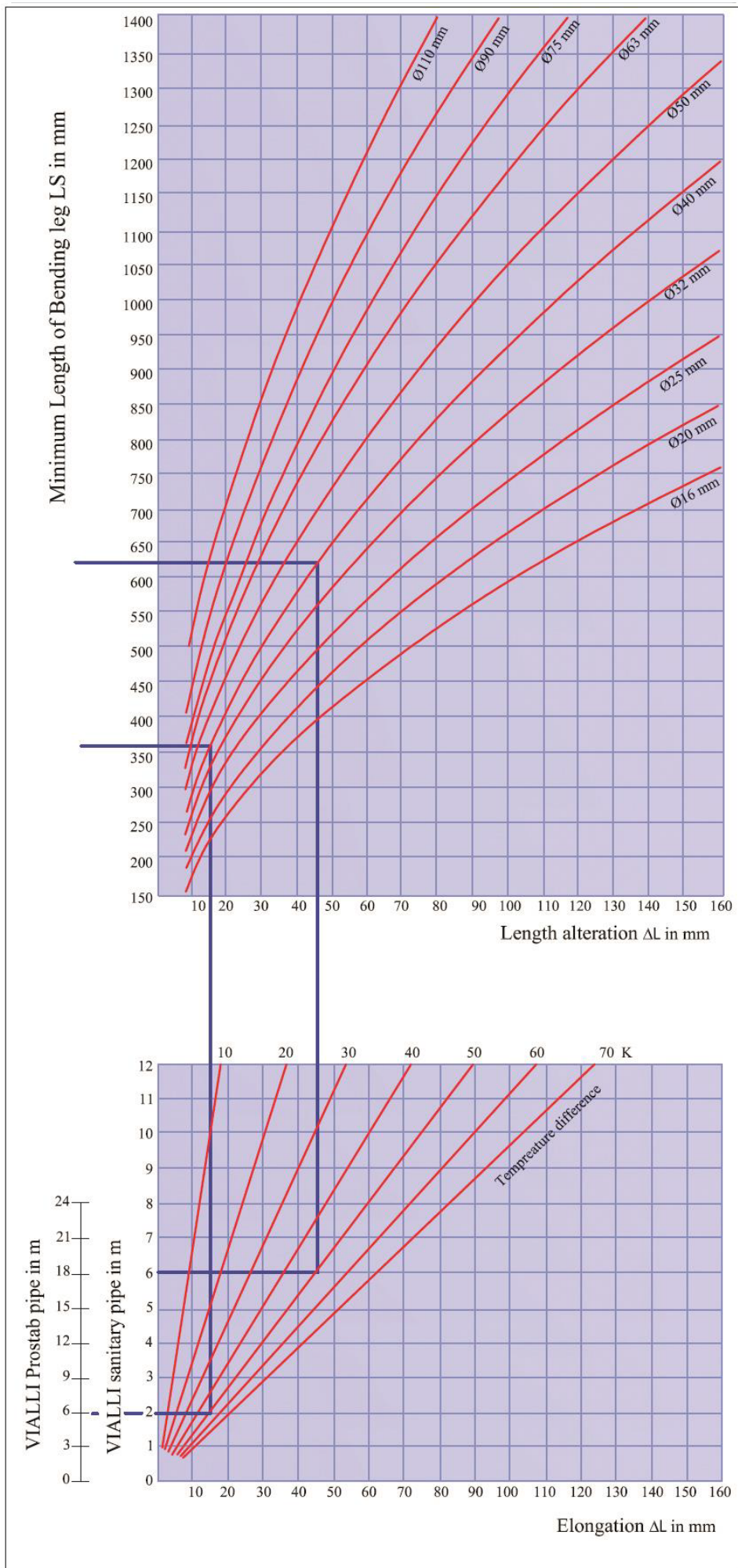

## Bearing Distance/Fixed reference point Version

### Bearing Distance

Arrangement of Fix points for Horizontal piping  
 Bearing Distance for VIALLI pipe to PN20 – PN25

Temp. °C	External Diameter pipe mm									
	16	20	25	32	40	50	63	75	90	110
Fixing intervals cm										
0	70	85	105	125	140	165	190	205	220	225
20	50	60	75	90	100	120	140	160	160	220
30	50	60	75	90	100	120	140	150	160	215
40	50	60	70	80	90	110	130	140	150	210
50	50	60	70	80	90	110	130	140	150	200
60	50	55	65	75	85	100	115	125	140	180
70	50	50	60	70	85	95	105	115	125	175

### Bearing Distance VIALLI prostab pipe

Temp. °C	External Diameter pipe mm								
	16	20	25	32	40	50	63	75	90
Fixing intervals cm									
0	130	155	170	195	220	245	270	285	300
20	100	120	130	150	170	190	210	220	230
30	100	120	130	150	170	190	210	220	230
40	100	110	120	130	160	180	200	210	230
50	100	110	120	140	160	180	200	210	220
60	80	100	110	130	150	170	190	200	210
70	70	90	100	120	140	160	180	190	200

### Fixed Point Version

A fix point is established by welding sleeves or other molded parts on either side of the pipe clip. Fixed points to be arrange in a line need to be so selected that alterations in direction in the pipe route are exploited.



## Drop in pressure owing to pipe friction

Pressure drops owing to pipe friction and calculated flow speed depending on peak flow for all pipes of the VIALLI installation system.

Following charts of pressure drops resulting from pipe friction were established in analogy to DIN 1988, Section 3.

Starting Values:

- Reference Temperature 10°C
- Reference pressure 10 bar
- Absolute roughness of interior pipe wall  $K = 0.007$  mm  
(Calculation of pipe friction coefficient according to Colebrook White)

### Note:

Pressure losses resulting from pipe friction change only insignificantly in the operating temperature range (up to 60°C) of Domestic Cold & Hot water supply system, therefore it is customary for the house installation to calculate with an overall supply pipes reference temperature of 10 °C (DIN 1988)

The legal unit used (SI unit) for pressure is the Pa (Pascal) Value, However, DIN standards refers to bar unit or mbar, respectively. Should the loss in pressure required in practice be the Pascal Value, the Following ratio will apply: 1 mbar = 100 Pa.

Intermediate values not indicated in the tables may be interring polated. It should be noted, however, that no liner functions serve as basis.

Losses in pressure of the Prostab pipes may be seen from the tables of nominal pressure degree PN20 &PN25 as the inner pipes have the same Dimensions.

## Pressure drops owing to pipe friction (R) and calculated flow speed (V) depending on peak flow (Vs)

### Polypropylene pipes

Type 3 in acc. with **DIN 8077**, nominal pressure Degree **PN16**

Peak Flow Vs L/s	DN 10 da = 16mm di = 11.6mm		DN 12 da = 20mm di = 14.4mm		DN 16 da = 25mm di = 18.0mm	
	R mbar/m	V m/s	R mbar/m	V m/s	R mbar/m	V m/s
0.01	0.18	0.09	0.04	0.06	0.02	0.04
0.02	0.59	0.19	0.21	0.12	0.07	0.08
0.03	1.19	0.28	0.42	0.18	0.15	0.12
0.04	1.96	0.38	0.70	0.25	0.24	0.16
0.05	2.90	0.47	1.03	0.31	0.36	0.20
0.06	4.01	0.57	1.42	0.37	0.49	0.24
0.07	5.27	0.66	1.86	0.43	0.64	0.28
0.08	6.68	0.76	2.36	0.49	0.81	0.31
0.09	8.25	0.85	2.91	0.55	1.00	0.35
0.10	9.97	0.95	3.51	0.61	1.20	0.39
0.12	13.85	1.14	4.86	0.74	1.66	0.47
0.14	18.31	1.32	6.40	0.86	2.18	0.55
0.16	23.34	1.51	8.14	0.98	2.77	0.63
0.18	28.93	1.70	10.07	1.11	3.42	0.71
0.20	35.09	1.89	12.19	1.23	4.13	0.79
0.30	74.18	2.84	25.55	1.84	8.58	1.18
0.40	126.91	3.78	43.42	2.46	14.50	1.57
0.50	193.69	4.73	65.73	3.07	21.84	1.96
0.60	273.37	5.68	92.42	3.68	30.59	2.36
0.70	366.39	6.62	123.47	4.30	40.72	2.75
0.80	472.71	7.57	159.33	4.91	52.23	3.14
0.90	592.31	8.52	199.09	5.53	65.10	3.54
1.00	725.17	9.46	243.16	6.14	79.34	3.93
1.20	1030.66	11.35	344.20	7.37	112.23	4.72
1.40	1389.12	13.25	462.41	8.60	150.22	5.50
1.60	1800.52	15.14	597.75	9.82	193.59	6.29
1.80	2264.83	17.03	750.22	11.05	242.32	7.07
2.00	2782.05	18.92	919.80	12.28	296.41	7.86
2.20	3352.17	20.82	1106.49	13.51	355.85	8.65
2.40	3875.17	22.71	1310.27	14.74	420.64	9.43
2.60	4651.06	24.60	1531.15	15.96	490.77	10.22
2.80	5379.84	26.49	1769.13	17.9	566.24	11.00
3.00	6161.49	29.39	2024.19	18.42	647.05	11.79
3.20	6996.02	30.28	2296.33	19.65	733.20	12.58
3.40	7883.42	32.17	2585.57	20.88	824.68	13.36
3.60	8823.70	34.06	2891.88	22.10	921.50	14.15
3.80	9816.85	35.96	3215.28	23.33	1023.65	14.93
4.00			3555.76	24.56	1131.13	15.72
4.20			3913.33	25.79	1243.94	16.50
4.40			4287.97	27.02	1362.08	17.29
4.60			4679.70	28.25	1485.56	18.08
4.80			5088.50	29.47	1614.36	18.86
5.00			5514.38	30.70	1748.49	19.65
5.20			5957.35	31.93	1887.95	20.43
5.40			6417.39	33.16	2023.75	21.22
5.60			6894.51	34.39	2182.87	22.01
5.80			7388.70	35.61	2338.31	22.79
6.00			7899.98	36.84	2499.09	23.58
6.20			8428.34	38.07	2664.19	24.36
6.40			8973.77	39.30	2836.63	25.15
6.60			9536.28	40.53	3013.39	25.94
6.80					3195.48	26.72
7.00					3382.89	27.51
7.50					3874.74	29.47
8.00					4399.89	31.44
9.00					5550.06	35.37
10.00					6833.41	39.30

## Pressure drops owing to pipe friction (R) and calculated flow speed (V) depending on peak flow (Vs)

### Polypropylene pipes

Type 3 in acc. with **DIN 8077**, nominal pressure Degree **PN16**

Peak Flow	DN 20 da = 32mm di = 23.0mm		DN 25 da = 40mm di = 28.8mm		DN 32 da = 50mm di = 36.2mm	
	Vs L/s	R mbar/m	V m/s	R mbar/m	V m/s	R mbar/m
0.01	0.01	0.02	0.00	0.02	0.00	0.01
0.02	0.02	0.05	0.01	0.03	0.00	0.02
0.03	0.05	0.07	0.02	0.05	0.00	0.03
0.04	0.08	0.10	0.03	0.06	0.01	0.04
0.05	0.11	0.12	0.04	0.08	0.01	0.05
0.06	0.15	0.14	0.05	0.09	0.02	0.06
0.07	0.20	0.17	0.07	0.11	0.02	0.07
0.08	0.25	0.19	0.09	0.12	0.03	0.08
0.09	0.31	0.22	0.11	0.14	0.04	0.09
0.10	0.37	0.24	0.13	0.15	0.04	0.10
0.12	0.51	0.29	0.18	0.18	0.06	0.12
0.14	0.67	0.34	0.23	0.21	0.08	0.14
0.16	0.85	0.39	0.29	0.25	0.10	0.16
0.18	1.05	0.43	0.36	0.28	0.12	0.17
0.20	1.27	0.48	0.43	0.31	0.14	0.19
0.30	2.61	0.72	0.88	0.46	0.30	0.29
0.40	4.39	0.96	1.48	0.61	0.49	0.39
0.50	6.58	1.20	2.21	0.77	0.73	0.49
0.60	9.18	1.44	3.07	0.92	1.02	0.58
0.70	12.18	1.68	4.06	1.07	1.34	0.68
0.80	15.58	1.93	5.18	1.23	1.71	0.78
0.90	19.36	2.17	6.43	1.38	2.11	0.87
1.00	23.53	2.41	7.80	1.54	2.56	0.97
1.20	33.04	2.89	10.91	1.84	3.57	1.17
1.40	44.07	3.37	14.50	2.15	4.73	1.36
1.60	56.62	3.85	18.57	2.46	6.04	1.55
1.80	70.93	4.33	23.13	2.76	7.50	1.75
2.00	86.53	4.81	28.16	3.07	9.11	1.94
2.20	103.63	5.30	33.66	3.38	10.87	2.14
2.40	122.22	5.78	39.63	3.68	12.78	2.33
2.60	142.32	6.26	46.07	3.99	14.83	2.53
2.80	163.91	6.74	53.17	4.30	17.02	2.72
3.00	186.99	7.22	60.56	4.61	19.36	2.91
3.20	211.56	7.70	68.42	4.91	21.85	3.11
3.40	237.63	8.18	76.74	5.22	24.48	3.30
3.60	265.18	8.66	85.53	5.53	27.25	3.50
3.80	294.23	9.15	94.78	5.83	30.17	3.69
4.00	324.76	9.36	104.50	6.14	33.23	3.89
4.20	356.78	10.11	114.67	6.45	36.57	4.08
4.40	390.29	10.59	125.32	6.75	39.91	4.28
4.60	425.28	11.07	136.42	7.06	43.41	4.47
4.80	461.77	11.55	147.99	7.37	47.04	4.66
5.00	499.73	12.03	160.01	7.68	50.82	4.86
5.20	539.19	12.52	172.50	7.98	54.73	5.05
5.40	580.13	13.00	185.46	8.29	58.79	5.25
5.60	622.55	13.48	198.87	8.60	62.99	5.44
5.80	666.46	13.96	212.75	8.90	67.33	5.64
6.00	711.86	14.44	227.08	9.21	71.81	5.83
6.20	758.74	14.92	241.88	9.52	76.44	6.02
6.40	807.11	15.40	257.14	9.82	81.20	6.22
6.60	856.96	15.89	272.86	10.13	86.11	6.41
6.80	908.29	16.37	289.04	10.44	91.15	6.61
7.00	961.11	16.85	305.68	10.75	96.34	6.80
7.50	1099.66	18.05	349.30	11.51	109.92	7.29
8.00	1247.48	19.26	395.80	12.28	124.38	7.77
9.00	1570.95	21.66	497.44	13.82	155.94	8.74
10.00	1931.52	24.07	610.57	15.35	191.01	9.72



## Pressure drops owing to pipe friction (R) and calculated flow speed (V) depending on peak flow (Vs)

### Polypropylene pipes

Type 3 in acc. with **DIN 8077**, nominal pressure Degree **PN16**

Peak Flow Vs L/s	DN 40 da = 63mm di = 45.6mm		DN 50 da = 75mm di = 54.2mm		DN 60 da = 90mm di = 65.0mm		DN 90 da = 110mm di = 79.6mm	
	R mbar/m	V m/s	R mbar/m	V m/s	R mbar/m	V m/s	R mbar/m	V m/s
0.01	0.00	0.01	0.00	0.00	0.00	0.00	0.00	0.00
0.02	0.00	0.01	0.00	0.01	0.00	0.01	0.00	0.00
0.03	0.00	0.02	0.00	0.01	0.00	0.01	0.00	0.00
0.04	0.00	0.02	0.00	0.02	0.00	0.01	0.00	0.00
0.05	0.00	0.03	0.00	0.05	0.00	0.02	0.00	0.00
0.06	0.01	0.04	0.00	0.03	0.00	0.02	0.00	0.00
0.07	0.01	0.04	0.00	0.03	0.00	0.02	0.00	0.00
0.08	0.01	0.05	0.00	0.03	0.00	0.02	0.00	0.00
0.09	0.01	0.06	0.01	0.04	0.00	0.03	0.00	0.00
0.10	0.01	0.06	0.01	0.04	0.00	0.03	0.00	0.00
0.12	0.02	0.07	0.01	0.05	0.00	0.04	0.00	0.00
0.14	0.03	0.09	0.01	0.06	0.00	0.04	0.00	0.00
0.16	0.03	0.10	0.01	0.07	0.01	0.05	0.00	0.00
0.18	0.04	0.11	0.02	0.08	0.01	0.05	0.00	0.00
0.20	0.05	0.12	0.02	0.09	0.01	0.06	0.00	0.00
0.30	0.10	0.18	0.04	0.13	0.02	0.09	0.01	0.06
0.40	0.16	0.24	0.07	0.17	0.03	0.12	0.01	0.08
0.50	0.24	0.31	0.11	0.22	0.04	0.15	0.02	0.10
0.60	0.33	0.37	0.15	0.26	0.06	0.18	0.02	0.12
0.70	0.44	0.43	0.19	0.30	0.08	0.21	0.03	0.14
0.80	0.56	0.49	0.24	0.35	0.10	0.24	0.04	0.16
0.90	0.69	0.55	0.30	0.39	0.13	0.27	0.05	0.18
1.00	0.84	0.61	0.36	0.43	0.15	0.30	0.06	0.20
1.20	1.16	0.73	0.50	0.52	0.21	0.36	0.08	0.24
1.40	1.54	0.86	0.67	0.61	0.28	0.42	0.10	0.28
1.60	1.96	0.98	0.85	0.69	0.35	0.48	0.13	0.32
1.80	2.43	1.10	1.05	0.78	0.44	0.54	0.16	0.36
2.00	2.94	1.22	1.27	0.87	0.53	0.60	0.20	0.40
2.20	3.51	1.35	1.51	0.95	0.63	0.66	0.24	0.44
2.40	4.11	1.47	1.77	1.04	0.73	0.72	0.28	0.48
2.60	4.77	1.59	2.05	1.13	0.85	0.78	0.32	0.52
2.80	5.47	1.71	2.35	1.21	0.97	0.84	0.36	0.56
3.00	6.21	1.84	2.67	1.30	1.10	0.90	0.41	0.60
3.20	7.00	1.96	3.00	1.39	1.24	0.96	0.46	0.64
3.40	7.83	2.08	3.35	1.47	1.38	1.02	0.52	0.68
3.60	8.70	2.20	3.73	1.56	1.54	1.08	0.57	0.72
3.80	9.62	2.33	4.12	1.65	1.69	1.15	0.63	0.76
4.00	10.59	2.45	4.53	1.73	1.86	1.21	0.69	0.80
4.20	11.60	2.57	4.96	1.82	2.04	1.27	0.76	0.84
4.40	12.56	2.69	5.40	1.91	2.22	1.33	0.83	0.88
4.60	13.74	2.82	5.86	1.99	2.41	1.39	0.90	0.92
4.80	14.88	2.94	6.35	2.08	2.60	1.45	0.97	0.96
5.00	16.06	3.06	6.85	2.17	2.81	1.51	1.04	1.00
5.20	17.29	3.18	7.36	2.25	3.02	1.57	1.12	1.04
5.40	18.56	3.31	7.90	2.34	3.24	1.63	1.20	1.08
5.60	19.87	3.43	8.45	2.43	3.46	1.69	1.29	1.12
5.80	21.23	3.55	9.03	2.51	3.69	1.75	1.37	1.16
6.00	22.62	3.67	9.61	2.60	3.93	1.81	1.46	1.20
6.20	24.16	3.80	10.22	2.69	4.18	1.87	1.55	1.24
6.40	25.65	3.92	10.85	2.77	4.43	1.93	1.64	1.28
6.60	27.18	4.04	11.49	2.86	4.69	1.99	1.74	1.32
6.80	28.75	4.16	12.15	2.95	4.96	2.05	1.84	1.36
7.00	30.37	4.29	12.83	3.03	5.23	2.11	1.94	1.40
7.50	34.60	4.59	14.60	3.25	5.95	2.26	2.20	1.51
8.00	39.09	4.90	16.48	3.47	6.71	2.41	2.48	1.61
9.00	48.88	5.51	20.66	3.90	8.36	2.71	3.08	1.81
10.00	59.73	6.12	25.30	4.33	10.91	3.01	3.75	2.01

## Pressure drops owing to pipe friction (R) and calculated flow speed (V) depending on peak flow (Vs)

### Polypropylene pipes

Type 3 in acc. with **DIN 8077**, nominal pressure Degree **PN20**

Peak Flow	DN 10 da = 16mm di = 10.6mm v = 0.088 l/m		DN 12 da = 20mm di = 13.2mm v = 0.137 l/m		DN 16 da = 25mm di = 16.6mm v = 0.216 l/m	
	Vs L/s	R mbar/m	V m/s	R mbar/m	V m/s	R mbar/m
0.01	0.39	0.11	0.14	0.07	0.05	0.05
0.02	1.23	0.23	0.44	0.15	0.15	0.09
0.03	2.44	0.34	0.87	0.22	0.30	0.14
0.04	3.98	0.45	1.41	0.29	0.48	0.18
0.05	5.84	0.57	2.07	0.37	0.70	0.23
0.06	8.00	0.68	2.83	0.44	0.96	0.28
0.07	10.47	0.79	3.69	0.51	1.25	0.32
0.08	13.22	0.91	4.65	0.58	1.57	0.37
0.09	16.24	1.02	5.70	0.66	1.92	0.42
0.10	19.50	1.13	6.86	0.73	2.30	0.46
0.15	39.92	1.70	13.92	1.10	4.66	0.69
0.20	66.61	2.27	23.13	1.46	7.72	0.92
0.25	99.54	2.83	34.38	1.83	11.45	1.16
0.30	138.44	3.40	47.68	2.19	15.80	1.39
0.35	183.23	3.97	62.92	2.56	20.79	1.62
0.40	223.51	4.53	79.92	2.92	26.33	1.85
0.45	289.41	5.10	98.10	3.29	32.55	2.08
0.50	351.24	5.67	119.82	3.65	39.38	2.31
0.55			142.53	4.02	46.68	2.54
0.60			167.44	4.38	54.62	2.77
0.65			193.092	4.75	72.14	3.00
0.70			219.6	5.12	82.09	3.23
0.75			251.39	5.48	92.17	3.47
0.80					103.12	3.70
0.85					114.05	3.93
0.90					125.91	4.16
0.95					138.87	4.39
1.00					151.69	4.62
1.05					164.92	4.85
1.10					179.41	5.08
1.15					193.50	5.31
1.20						5.54

## Pressure drops owing to pipe friction (R) and calculated flow speed (V) depending on peak flow (Vs)

### Polypropylene pipes

Type 3 in acc. with **DIN 8077**, nominal pressure Degree **PN20**

Peak Flow	DN 20 da = 32mm di = 21.2mm v = 0.352 l/m		DN 25 da = 40mm di = 26.6 mm v = 0.556 l/m		DN 32 da = 50mm di = 33.2mm v = 0.866 l/m	
	Vs L/s	R mbar/m	V m/s	R mbar/m	V m/s	R mbar/m
0.05	0.22	0.14	0.08	0.09	0.03	0.06
0.10	0.72	0.28	0.25	0.18	0.09	0.12
0.15	1.46	0.42	0.50	0.27	0.17	0.17
0.20	2.40	0.57	0.82	0.36	0.29	0.23
0.25	3.55	0.71	1.21	0.45	0.42	0.29
0.30	4.89	0.85	1.65	0.54	0.58	0.35
0.35	6.42	0.99	2.17	0.63	0.76	0.40
0.40	8.15	1.13	2.75	0.72	0.95	0.46
0.45	10.04	1.27	3.38	0.81	1.17	0.52
0.50	12.11	1.42	4.06	0.90	1.41	0.58
0.60	16.76	1.70	5.63	1.08	1.95	0.69
0.70	22.07	1.98	7.40	1.26	2.55	0.81
0.80	28.10	2.27	9.39	1.44	3.24	0.92
0.90	34.64	2.55	11.58	1.62	3.99	1.04
1.00	42.01	2.83	14.00	1.80	4.82	1.16
1.10	49.92	3.12	16.64	1.98	5.71	1.27
1.20	58.59	3.40	19.45	2.16	6.65	1.39
1.30	67.80	3.68	22.42	2.34	7.71	1.50
1.40	77.52	3.97	25.64	2.52	8.78	1.63
1.50	88.14	4.25	29.16	2.70	9.95	1.73
1.60	98.83	4.53	32.72	2.88	11.16	1.85
1.70	110.48	4.82	36.58	3.06	12.48	1.96
1.80	122.63	5.10	40.62	3.24	13.80	2.08
1.90	135.95	5.38	44.82	3.42	15.23	2.19
2.00			49.17	3.64	16.72	2.31
2.10			53.67	3.78	18.25	2.43
2.20			58.61	3.96	19.84	2.54
2.30			63.42	4.14	21.58	2.66
2.40			68.70	4.32	23.26	2.77
2.50			73.70	4.50	25.11	2.89
2.60			79.40	4.68	26.89	3.00
2.70			85.18	4.86	28.85	3.12
2.80			91.13	5.04	30.87	3.23
2.90			97.24	5.22	32.78	3.35
3.00			103.51	5.40	34.90	3.47
3.10					37.07	3.58
3.20					39.30	3.70
3.30					41.57	3.81
3.40					43.90	3.93
3.50					46.27	4.04
3.60					48.95	4.16
3.70					51.43	4.27
3.80					53.96	4.39
3.90					56.53	4.51
4.00					59.15	4.62
4.10					62.14	4.74
4.20					64.86	4.85
4.30					67.61	4.97
4.40					70.79	5.08
4.50					73.64	5.20

## Pressure drops owing to pipe friction (R) and calculated flow speed (V) depending on peak flow (Vs)

### Polypropylene pipes

Type 3 in acc. with **DIN 8077**, nominal pressure Degree **PN20**

Peak Flow Vs L/s	DN 40 da = 63mm di = 42.0mm v = 1.385 l/m		DN 50 da = 75mm di = 50.0mm v = 1.963 l/m		DN 60 da = 90mm di = 60.0mm v = 2.827 l/m		DN 90 da = 110mm di = 73.2mm v = 4.200 l/m	
	R mbar/m	V m/s	R mbar/m	V m/s	R mbar/m	V m/s	R mbar/m	V m/s
0.25	0.03	0.07	0.01	0.05	0.01	0.04	0.01	0.06
0.50	0.09	0.14	0.04	0.10	0.02	0.07	0.03	0.12
0.75	0.19	0.22	0.08	0.15	0.04	0.11	0.07	0.18
1.00	0.31	0.29	0.14	0.20	0.06	0.14	0.11	0.24
1.25	0.46	0.36	0.20	0.25	0.08	0.18	0.16	0.30
1.50	0.94	0.54	0.41	0.38	0.17	0.27	0.22	0.36
1.75	1.56	0.72	0.68	0.51	0.28	0.35	0.29	0.42
2.00	2.32	0.90	1.00	0.64	0.42	0.44	0.37	0.48
2.25	3.21	1.08	1.39	0.76	0.58	0.53	0.46	0.53
2.50	4.22	1.26	1.83	0.89	0.76	0.62	0.55	0.59
2.75	5.36	1.44	2.31	1.02	0.97	0.71	0.66	0.65
3.00	6.62	1.62	2.86	1.15	1.19	0.80	0.77	0.71
3.25	8.02	1.80	3.45	1.27	1.44	0.88	0.88	0.77
3.50	9.52	1.98	4.10	1.40	1.70	0.97	1.01	0.83
3.75	11.16	2.17	4.81	1.53	1.99	1.06	1.14	0.89
4.00	12.90	2.35	5.53	1.66	2.30	1.15	1.28	0.95
4.25	14.74	2.53	6.32	1.78	2.63	1.24	1.43	1.01
4.50	16.74	2.71	7.18	1.91	2.98	1.33	1.59	1.07
4.75	18.85	2.89	8.05	2.04	3.34	1.41	1.75	1.13
5.00	21.06	3.07	8.99	2.16	3.73	1.50	1.92	1.19
5.25	23.36	3.25	9.98	2.29	4.14	1.59	2.09	1.25
5.50	25.74	3.43	11.00	2.42	4.56	1.68	2.27	1.31
5.75	28.21	3.61	12.12	2.55	5.00	1.77	2.46	1.37
6.00	30.94	3.79	13.22	2.67	5.46	1.86	2.67	1.43
6.25	33.76	3.97	14.43	2.80	5.96	1.95	2.86	1.49
6.50	36.49	4.15	15.60	2.93	6.44	2.03	3.08	1.54
6.75	39.51	4.33	16.90	3.06	6.98	2.12	3.29	1.60
7.00	42.63	4.51	18.23	3.18	7.49	2.21	3.51	1.66
7.25	45.85	4.69	19.50	3.31	8.06	2.30	3.75	1.72
7.50	49.16	4.87	20.91	3.44	8.64	2.39	3.99	1.78
7.75	52.57	5.05	22.36	3.57	9.19	2.48	4.24	1.84
8.00	56.06	5.25	23.85	3.69	9.81	2.56	4.47	1.90
8.25			25.83	3.82	10.43	2.65	4.72	1.96
8.50			26.95	3.95	11.08	2.74	4.99	2.02
8.75			28.55	4.07	11.74	2.83	5.26	2.08
9.00			32.04	4.33	13.10	3.01	5.56	2.14
9.25			35.50	4.58	14.60	3.18	5.84	2.20
9.50			39.32	4.84	16.08	3.36	6.13	2.26
9.75			43.31	5.09	17.72	3.54	6.41	2.32
10.00			47.18	5.35	19.30	3.71	6.71	2.38
10.25					21.06	3.89	7.05	2.44
10.50					22.88	4.07	7.35	2.50
10.75					24.76	4.24	7.66	2.55
11.00					26.71	4.42	7.98	2.61
11.25					28.71	4.60	8.35	2.67
11.50					30.77	4.77	8.67	2.73
11.75					32.89	4.95	9.00	2.79
12.00					35.06	5.13	9.38	2.85
12.25					37.28	5.31	9.72	2.91

## Pressure drops owing to pipe friction (R) and calculated flow speed (V) depending on peak flow (Vs)

### Polypropylene pipes

Type 3 in acc. with **DIN 8077**, nominal pressure Degree **PN20**

Peak Flow	DN 12 da = 20mm di = 12.0mm v = 0.1132 l/m		DN 15 da = 25mm di = 15.0mm v = 0.177 l/m		DN 20 da = 31mm di = 19.2mm v = 0.290 l/m	
	Vs L/s	R mbar/m	V m/s	R mbar/m	V m/s	R mbar/m
0.01	0.22	0.09	0.08	0.06	0.02	0.03
0.02	0.69	0.18	0.24	0.11	0.08	0.07
0.03	1.36	0.27	0.48	0.17	0.15	0.10
0.04	2.21	0.35	0.78	0.23	0.24	0.14
0.05	3.25	0.44	1.13	0.28	0.35	0.17
0.06	4.44	0.53	1.54	0.34	0.48	0.21
0.07	5.79	0.62	2.01	0.40	0.63	0.24
0.08	7.32	0.71	2.53	0.45	0.79	0.28
0.09	8.97	0.80	3.10	0.51	0.96	0.31
0.10	10.78	0.88	3.72	0.57	1.16	0.35
0.15	21.98	1.33	7.56	0.85	2.33	0.52
0.20	36.61	1.77	12.55	1.13	3.85	0.69
0.25	54.55	2.21	18.61	1.41	5.71	0.86
0.30	75.62	2.65	25.74	1.70	7.85	1.04
0.35	99.74	3.09	33.86	1.98	10.31	1.21
0.40	127.15	3.54	43.03	2.26	13.07	1.38
0.45	157.62	3.98	53.16	2.55	16.16	1.55
0.50	191.34	4.42	64.30	2.83	19.49	1.73
0.55	227.58	4.86	76.51	3.11	23.11	1.90
0.60	266.15	5.31	89.52	3.40	27.06	2.07
0.65			103.71	3.68	31.23	2.25
0.70			118.71	3.96	35.61	2.42
0.75			134.47	4.24	40.36	2.59
0.80			150.95	4.53	45.32	2.76
0.85			168.86	4.81	50.72	2.94
0.90			187.58	5.09	56.10	3.11
0.95			207.08	5.38	61.95	3.28
1.00					68.02	3.45
1.05					74.31	3.63
1.10					80.80	3.80
1.15					87.90	3.97
1.20					94.82	4.14
1.25					12.40	4.32
1.30					109.71	4.49
1.35					117.74	4.66
1.40					126.02	4.84
1.45					134.52	5.01
1.50					143.26	5.18
1.55					151.48	5.35

## Pressure drops owing to pipe friction (R) and calculated flow speed (V) depending on peak flow (Vs)

### Polypropylene pipes

Type 3 in acc. with **DIN 8077**, nominal pressure Degree **PN25**

Peak Flow Vs L/s	DN 25 da = 40mm di = 24.0mm v = 0.452 l/m		DN 30 da = 50mm di = 30.0mm v = 0.707 l/m	
	R mbar/m	V m/s	R mbar/m	V m/s
0.05	0.12	0.11	0.04	0.07
0.10	0.40	0.22	0.14	0.14
0.15	0.81	0.33	0.28	0.21
0.20	1.33	0.44	0.46	0.28
0.25	1.97	0.55	0.68	0.35
0.30	2.70	0.66	0.93	0.42
0.35	3.54	0.77	1.22	0.50
0.40	4.49	0.88	1.55	0.57
0.45	5.52	0.99	1.90	0.64
0.50	6.67	1.11	2.28	0.71
0.60	9.20	1.33	3.16	0.85
0.70	12.12	1.55	4.15	0.99
0.80	15.44	1.77	5.27	1.13
0.90	19.04	1.99	6.48	1.27
1.00	23.00	2.21	7.48	1.14
1.10	27.34	2.43	9.28	1.56
1.20	31.95	2.65	10.85	1.70
1.30	36.98	2.87	12.57	1.84
1.40	42.29	3.09	14.32	1.98
1.50	48.09	3.32	16.21	2.12
1.60	53.93	3.54	18.27	2.26
1.70	60.30	3.76	20.34	2.41
1.80	66.94	3.98	22.58	2.55
1.90	73.85	4.20	24.92	2.69
2.00	81.01	4.42	27.35	2.83
2.10	88.87	4.64	29.86	2.97
2.20	96.55	4.86	32.61	3.11
2.30	104.99	5.08	35.28	3.25
2.40	113.73	5.31	38.04	3.40
2.50			41.06	3.54
2.60			44.19	3.68
2.70			47.17	3.82
2.80			50.46	3.96
2.90			53.85	4.10
3.00			57.33	4.24
3.10			60.89	4.39
3.20			64.54	4.53
3.30			68.28	4.67
3.40			72.09	4.81
3.50			75.99	4.95
3.60			80.39	5.09
3.70			84.46	5.23
3.80			88.61	5.38

## Pressure drops owing to pipe friction (R) and calculated flow speed (V) depending on peak flow (Vs)

### Polypropylene pipes

Type 3 in acc. with **DIN 8077**, nominal pressure Degree **PN25**

Peak Flow	DN 40 da = 63mm di = 37.8mm v = 1.122 l/m		DN 45 da = 75mm di = 45.0mm v = 1.590 l/m	
	Vs L/s	R mbar/m	V m/s	R mbar/m
0.10	0.05	0.09	0.02	0.06
0.20	0.15	0.18	0.07	0.13
0.30	0.31	0.27	0.14	0.19
0.40	0.51	0.36	0.22	0.25
0.50	0.76	0.45	0.33	0.31
0.75	1.55	0.67	0.67	0.47
1.00	2.58	0.89	1.12	0.63
1.25	3.84	1.11	1.66	0.79
1.50	5.32	1.34	2.30	0.94
1.75	7.01	1.56	3.03	1.10
2.00	8.91	1.78	3.85	1.26
2.25	11.06	2.00	4.76	1.41
2.50	13.32	2.23	5.74	1.57
2.75	15.88	2.45	6.81	1.73
3.00	18.62	2.67	7.98	1.89
3.25	21.52	2.90	9.23	2.04
3.50	24.57	3.12	10.54	2.20
3.75	27.91	3.34	11.98	2.36
4.00	31.42	3.56	13.42	2.52
4.25	35.09	3.79	14.99	2.67
4.50	38.92	4.01	16.63	2.83
4.75	43.12	4.23	18.43	2.99
5.00	47.26	4.46	20.20	3.14
5.25	51.81	4.68	22.03	3.30
5.50	56.54	4.90	24.05	3.46
5.75	61.11	5.12	26.14	3.62
6.00	66.16	5.35	28.14	3.77
6.25			30.37	3.93
6.50			32.66	4.09
6.75			35.02	4.24
7.00			37.44	4.40
7.25			39.94	4.56
7.50			42.49	4.72
7.75			45.11	4.87
8.00			48.06	5.03
8.25			50.82	5.19
8.50			53.62	5.34

## Determination of Total Pressure loss of the installation

- The calculations of flow rates of the individual take-off points are summed in a direction and are assigned to the corresponding pipe sections as cumulative flow rates.
- The dimensions are calculated from the sum of continuous flow rates and peak rates.
- The continuous flow rates is regarded as the quality which emerges when water is removed for more than 15 minutes, converted to liter per second.
- Values for the conversion of cumulative flow rates in to peak flow rates are shown in diagram.
- In association with international pipe diameter. The peak flow rates determine the pressure gradient due to pipe friction.
- The total pressure loss of the pipe (without equipment resistance) is the sum of the pressure losses due to pipe friction and individual resistance.
- The coefficients of resistance of pipeline sections and individual resistance are shown in table
- The total pressure loss of the pipe can be determined with the aid of the relevant equation:

$$\Delta P = \Sigma(R \times L + Z)$$

$$Z = \zeta \cdot \frac{V^2 \cdot e}{2}$$

### Peak Flow

Peak flow  $V_s$  depending on summation flow  $\Sigma V_R$

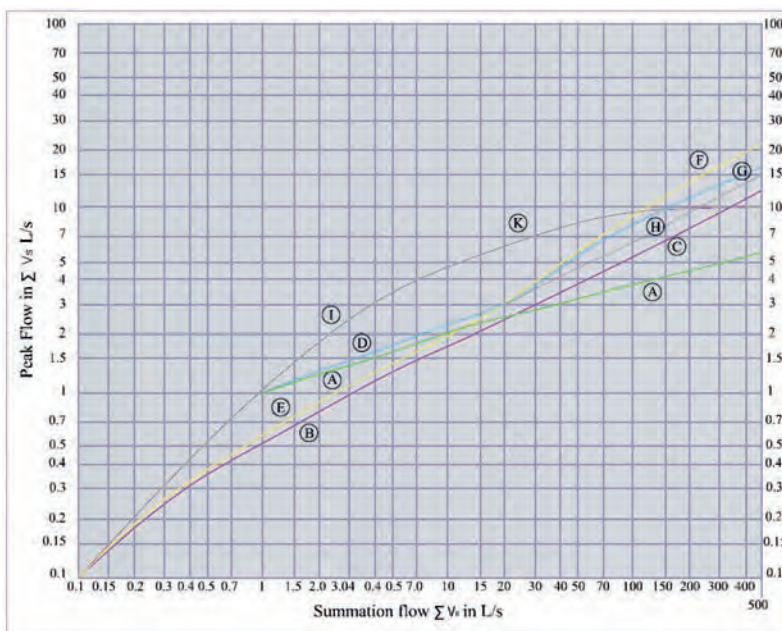

Area of Applications [VR ≤ 20 L/s]		
	[VR > 1.5 L/s]	[VR ≤ 1.5 L/s]
Residential buildings	(A) —	(B) —
Office and Administrative Buildings	(A) —	(B) —
Hotel Buildings	(D) —	(E) —
Department Stores	(D) —	(E) —
Hospitals (only ward sections)	(D) —	(E) —
Schools $\Sigma V_s = V_s$ von 0,1 bis 1,5 L/s		(I) —
		$\Sigma V_R > 1,5$ L/s

Area of Applications [VR > 20 L/s]	
Residential buildings	(A) —
Office and Administrative Buildings	(C) —
Hotel Buildings	(F) —
Department Stores	(G) —
Hospitals (only ward sections)	(H) —
Schools	(K) —

GERMANY

VIALLI GmbH

VIALLI®









## Resistance Coefficient Values

Resistance Coefficient Values  $\zeta_u$  for piping junctions

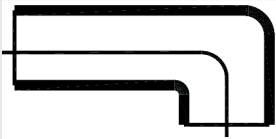
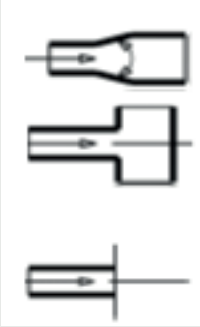
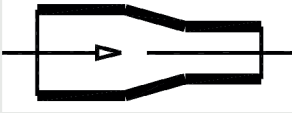
No.	Designation	Graphic Symbols	Loss coefficients
1	Branching. One sided dividing flow		1.3
2	Branching. One sided merging flow		0.9
3	Branching one-sided passage for dividing		0.3
4	Branching one-sided passage for merging flow		0.6
5	Branching one sided counter-current for merging flow		3.0
6	Branching one sided counter-current for dividing flow		1.3
7	Branching, one sided bow shaped dividing flow		0.9
8	Branching one sided bow shaped, merging flow		0.4
9	Branching one sided bow shaped passage for dividing flow		0.3
10	Branching one sided bow shaped passage for merging flow		0.2
11	Branching with 2 exit pipes (casing reservoir)		0.5
12	Branching with 2 entry pipes (casing reservoir)		1.0
13	Bow 90° smooth $R=d$ $=2d$ $=4d$ $=6d$ $=10d$ Bow 90° rough $R=d$ $=2d$ $=4d$ $=6d$ $=10d$		0.21 0.14 0.09 0.11 0.51 0.30 0.23 0.18 0.20

## Resistance Coefficient Values

Resistance Coefficient Values  $\zeta_u$  for piping junctions

No.	Designation	Graphic Symbols	Loss coefficients
14	Elbow joints 90° smooth Elbow joints 90° rough		1.13 1.27
15	Widening steady $\beta = 10^\circ$ $= 20^\circ$ $= 30^\circ$ $= 40^\circ$ Widening sudden Widening free discharge		0.20 0.45 0.60 0.75  (F1/F2=1)2  1.0
16	Narrowing steady  Reductions 1 dimensions 2 dimensions 3 dimensions 4 dimensions 5 dimensions 6 dimensions		0.40 0.50 0.60 0.70 0.80 0.90
17	Smooth comp tube bend quill comp tube bend corrugated comp tube		0.7 1.4 2
18	Screw-down stop Globe valve DN20 DN25  Slanted set valves DN20 DN25		8.5 7.0  2.5 2.0
19	Full current valve DN20 DN25		1.5
20	Corner valves DN20 DN25		2.0
21	Main slide valve DN20 DN25		0.5

## QUALITY CONSIDERATIONS

The deciding factor in the VIALLI PP-Rc pipes and fittings manufacturing process is the use of correct/ pure raw materials.

- Pipes and pipe fittings consist of long-lasting PP-Rc material properties and characteristics.
- Has a direct impact on the welding quality (example: the melting point of PP-Rc material is 140 °C that of PP-B material is about 160 °C) welding conditions become different so that the welding quality is easy to grasp. This is because two kinds of crystalline materials used in the PP blend mix have varying melting degrees.
- The cooling rate is different in the welding process due to the different shrinkage rates which leads to stress concentration.
- When the raw material is mixed with a number of recycling industrial waste plastic granulates, the pipes and fittings produced could be toxic and thus not suitable for long-term use to transport drinking water this will seriously damage people's health.
- During the welding process, there is an odor and an emission of black smoke.
- The lifespan of such pipes and fittings is rather short. Leakage problems will probably start within the first few months of regular use. The repair and replacement costs, especially in occupied residential units, will be much higher.

The production machines also play an important role in ensuring a quality product. Low-quality suppliers tend to use inexpensive equipment for their manufacturing process. For example, pipes may be produced with uneven wall thickness throughout the pipe. This can significantly impact the quality of the pipe and its chemical/thermal characteristics.

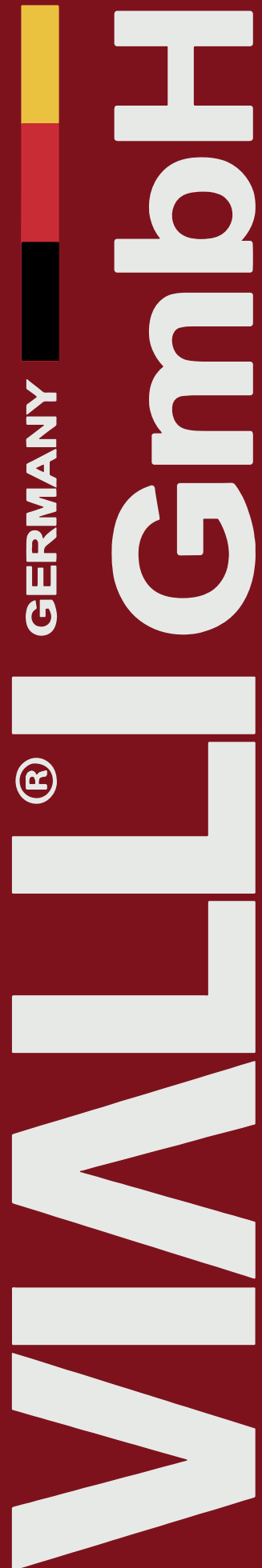

## VIALLI FIBER GLASS REINFORCED PIPE

### PRODUCT DESCRIPTION

FR-PPR Glass Fiber-reinforced hot and cold water composite pipes are three-layer co-extruded pipes. They are produced at low temperatures with high-speed production techniques and offer the special advantages of PP-Rc pipes. Additionally, they possess the following characteristics:

1. The linear expansion coefficient is only about 20-30% of that of ordinary PP-Rc pipes.
2. Enhances pipe rigidity, prevents sagging, provides additional support points, and thereby reduces the total installation cost.
3. Higher pressure resistance level and longer working life under several working conditions. (95 °C at 10bar for short time test 200 hours) 95 °C at 6.5 Bar for a service time 50 years.
4. Permanently solves the issue of oxygen ingress into the pipeline, ensuring that it does not appear on the inner surface. The middle layer of the FR-PPR pipe effectively prevents oxygen intrusion, inhibiting algae growth and maintaining fresh, pure water.
5. Exhibits good resistance to ultraviolet radiation, ensuring that the installation remains free from deformation.
6. Low thermal conductivity
  - PP-Rc Aluminum composite pipe coefficient of thermal conductivity is 190w/mk
  - PP-Rc Glass Fiber composite pipe coefficient of thermal conductivity is 110w/mk ideal
  - Choice for outdoor construction of solar and heat energy system.

### Raw Material and Technical Specifications

- Pipe Type: PP-Rc Glass-Fiber Reinforced
- Elongation coefficient: 0.035 mm/mk
- Fields of use: Heating, Cooling, internal and external cold and hot domestic water supply pipes system

### Liner Expansion Table for the VIALLI Composite Pipes

length	ΔT						
	10°C	20°C	30°C	40°C	50°C	60°C	70°C
M							
5	2	4	6	8	10	12	14
10	4	8	12	16	20	24	28
15	6	12	18	24	30	36	42
20	8	16	24	36	40	48	56

### Vialli Glass Fiber Reinforced Pipe

### Liner Expansion Table for the VIALLI Composite Pipes

Compares the amount of elongation from the glass fiber reinforcement PP-Rc pipe with the standard PP-Rc pipe

While fiberglass reinforced PP-Rc pipes elongate by 1.75mm per 1 meter at a temperature difference of 50°C, standard PP-Rc pipes elongate by 7.5mm per 1 meter under the same temperature difference.

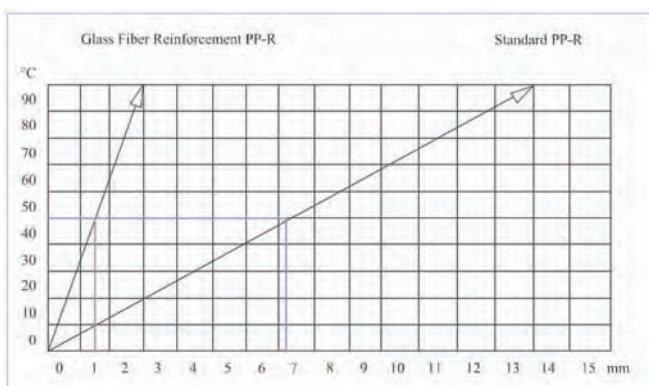

Code	Measure	Packet
VPPR20FG	20x3.4mm	100
VPPR25FG	25x4.2mm	100
VPPR32FG	32x5.4mm	60
VPPR40FG	40x6.7mm	40
VPPR50FG	50x8.4mm	20
VPPR63FG	63x10.5mm	16
VPPR75FG	75x12.5mm	12
VPPR90FG	90x15mm	8
VPPR110FG	110x18.3mm	4
VPPR160FG	160x26.6mm	4
VPPR200FG	200x28.3mm	4
VPPR250FG	250x33.3mm	4

## Vialli Aluminum Reinforced Pipe

### Product Description

VIALLI PN25 pipes (with an aluminum layer) consist of inside and outside layers made of PP-Rc. These layers are securely bonded to the middle layer, which is an aluminum core, using a PP-based adhesive and are well-welded in an overlapping manner. This type of pipe represents a perfect combination of a metal pipe and a plastic pipe.

### Advantages 1

- Greatly reduces linear expansion coefficient, only  $\frac{1}{4}$  of that of PP-Rc, which means the composite pipes have stable dimensions.
- 100% Oxygen tightness, suitable for heating system.
- Improved resistance to impulse under low temperature, resistant to UV-rays.
- Works under high temperatures and pressures for cool and hot water systems.
- Easily detectable when embedded, due to the presence of the metal layer.
- Excellent heat preservation performance with a low thermal conductivity coefficient of 0.45 W/m·K.
- Smooth and hygienic, making it an excellent choice for drinkable water systems.

### Advantages 2

- Suitable for the distribution of both cold and hot water.
- Pipes for a variety of high-temperature and low-temperature heating systems.
- Pipes for heating and cooling settings in solar energy systems.
- Duct for drinkable water system.
- Industrial transportation for chemical liquids.
- Pipes for connecting air conditioners.
- High-pressure pipes for irrigation systems

# VIALLI PP-RCT Pipes & Fittings

Building on the success of VIALLI PP-RC, we introduce the latest generation of polypropylene material: **VIALLI PP-RCT**

The polypropylene Random Copolymer (PP-RC) was developed with a special crystalline structure that exhibits an improved pressure rating at elevated pressure rating. It is called Polypropylene Random Crystalline Temperature (**PP-RCT**).

The crystalline structure is created through a special Nucleation process that enables the pipes and fittings to operate at higher pressure at elevated temperatures. Thanks to this structure the new generation of polypropylene (**VIALLI PP-RCT**) can be produced with higher compressive strength than PP-RC.

- **VIALLI PP-RCT** pipes are produced with thinner walls for the same application, which means they have a higher flow capacity with a consistent diameter.
- **VIALLI PP-RCT** (polypropylene –Random- Copolymer Temperature resistant) with a modified Crystal structure (Beta Nucleated) increased temperature resistance RAL 6024 Traffic Green.
- **VIALLI PP-RCT** is produced according to German DIN Standard (DIN 8077/ DIN 8078) and (DIN EN ISO 15874) and complies with the requirements of the KTW guideline of German Federal Environmental agency (U B A).
- **VIALLI PP-RCT** is produced by single Layer, homogeneous pipe for high pressure and temperatures with simultaneous high flow PN16 and PN20.
- **VIALLI PP-RCT** is produced with Multi-Layer Composite Fiber Glass (PN25), and Multi-Layer Composite Aluminum Middle Layer (PN25).



## MATERIAL

### SPECIFICATION OF RAW MATERIAL USED IN PRODUCTION:

- PP-RCT standard pipes & fittings are manufactured from Polypropylene Random copolymer with enhanced Crystalline structure and improved Temperature resistance.
- Brass inserts used in transition fittings is classified as CW617 (CuZn<sub>40</sub>Pb<sub>2</sub>) and suitable for drinking water installations.

#### **PP-RCT** (Polypropylene Random Crystalline Temperature).

Polypropylene random copolymer with special crystallinity by special “β nucleation” process providing an improved pressure resistance, especially at elevated temperatures.

- Special crystallinity structure – High degree of the Hexagonal for (β form).
- Improvement in long term strength 50% than regular PP-RC.
- Improved resistance to crack propagation.
- Lower wall thickness and higher hydraulic capacity.

Pipes of PP-RCT materials shows pressure resistance, according to ISO/TR 9080 with proven minimum required strength (MRS) of 11.5 Pa and Categorized Required Strength (CRS) of 5 MPa.

### POLYPROPYLENE MATERIAL :

Polypropylene is a thermoplastic material and belongs to the polyolefin groups. PP is a semi- crystalline material. PP’s mechanical properties, chemical resistance and specially relatively high heat deflection temperature have made PP, one of the most important material used in piping industry.

### THE MAIN FOUR TYPES OF POLYPROPYLENE ARE:

- Polypropylene Homo Polymer (PP-H) (Type 1) – high internal pressure resistance.
- Polypropylene Block Co-Polymer (PP-B) (Type 2) – High impact strength especially at low temperature & low thermal endurance – Sewage Pipe System.
- Polypropylene Random Co-Polymer (PP-R) (Type 3) High internal Pressure Resistance at high Temperature & low e-modulus - Plumbing and sanitary application
- Polypropylene Random Crystalline (PP-RCT) High internal Pressure Resistance at elevated temperature – Hot water & Heating system.

## PP-RCT ADVANTAGES

- Improved long-term strength of PP-RCT material leads to a more economic set of dimensions of the pipe system.
- It enables designers to select thinner wall pipes and in some situations also smaller diameter pipe can be used.
- This results in higher hydraulic pipe capacity or the possibility to apply higher pressure than with standard PP-R.
- A higher range of working temperature for a given application HOT or COOL.
- A life span of more than 50 years.
- PP-RCT is both safer and more economical (less man power required) to install.
- Create a homogeneous joint – welds are as strong or stronger than the pipe itself.
- Welding time is significantly reduced compared to metal options.
- No noxious fumes are created by the welding process, making it ideal for enclosed spaces or building that will be applying for LEED certification.
- PPR-CT has an extremely high corrosion resistance – systems have a design life span of more than 50 years, with no corrosion during this entire period.
- Compared to PP-R piping systems, PP-RCT may allow for a thinner walled pipe in the same application, increasing flow capacity.
- PP-RCT is a natural insulating material, while metallic pipes are naturally conductive.
- In certain application, the insulation value provided by the pipe wall alone may prove sufficient to avoid condensation or retain the desired water temperature.
- Low noise, the absorption properties and elasticity of this material soften noise and vibration caused by the water flow and water hammer effect.





## PP-RCT PROPERTIES

### MECHANICAL PROPERTIES

	PROPERTY	Standard	Unit	PP-RCT
Mechanical Properties	MRF 190/5 MRF 230/2.16	ISO 1183 -	G/10min -	0.5 0.24 – 0.36
	MFI range	ISO1872/18 73	-	T003
	Elongation at break	ISO 527	%	>300
	Flexural strength (3.5% flexural stress)	ISO 178	MPa	23
	Modulus of elasticity	ISO 527	MPa	900
Thermal Properties	Thermal conductivity at 20°C	DIN 52612	W/(m x K)	0.24
	Specific heat at 20°C	-	kJ / Kg K	2.0
Electrical Properties	Specific volume resistance	VDE 0303	OHM cm	-
	Specific surface resistance	VDE 0303	OHM	>1013
	Relative dielectric constant at 1 MHz	DIN 53483	-	23
Other	Physiologically non - toxic	EEC 90/128	-	Yes
	FDA	-	-	Yes

### PHYSICAL PROPERTIES

	PROPERTY	Standard	Unit	PP-RCT
	Density	ISO 1183	g/cm <sup>3</sup>	0.905
	Melt flow rate	230°C, 2.16 kg 190 °C, 5.0 Kg	ISO 1183	G/10min 0.25 0.45
	Tensile stress at yield	Yield point	ISO 527	MPa 25
	Elongation at yield		ISO 527	% 10
	Flexural Modulus		ISO 527	MPa 900
	Charpy Impact Strength	23°C 0°C	ISO 179	KJ /m <sup>2</sup> 40 4
	Coefficient of thermal expansion (0°C /70°C)		DIN 53752	K <sup>-1</sup> 1.5 x 10 <sup>4</sup>

### CLASSIFICATIONS

Pipe systems are typically used for domestic hot & cold water supply such as:

- Drinking water – fresh water up to 25°C temp. for drinking and cooking.
- Hot tap water – Heated Drinking water up to a temperature 60°C.
- Sanitary application – Drinking water quality is not needed, like flush system, washing & irrigation.

Wrong choice of piping material may cause failure of installation and have a quantitative influence on the quality of water which we consume. Vialli PP-RCT follow the standard of EN ISO 15874 classifies the service condition for hot and cold water application.

## MATERIAL STRENGTH & RESISTANCE (LIFE CYCLE)

One of the most important properties of a polymer material used for hot and cold water pressure pipes is its resistance to internal pressure at different temperatures. Also creep behavior is an important factor to take consideration for plastic pipe system.

### Stress details for PP-R and PP-RCT

Application class	Design stress for PP-R		Design stress for PP-RCT	
	Mpa	Bar	Mpa	Bar
1	3.90	30.9	3.63	36.3
2	2.13	21.3	3.40	34.0
4	3.30	33.0	3.67	36.7
5	1.90	19.0	2.92	29.2
20°C / 50 years	6.93	69.3	8.24	82.3

### Safety Factor & Design Stress

Temperature	Safety Factor (SF)	
	PP-R	PP-RCT
°C		
TD	1.5	1.5
Tmax	1.3	1.3
Tmal	1.0	1.0
Tcold	1.4	1.4

TD = Design Temperature  
 Tmax = Max Temperature  
 Tmal = Failure Temperature  
 Tcold = Cold water

### Safety Factor & Design Stress

Temperature		Time Years	Required long term strength PP-R		Required long term strength PP-RCT	
			Mpa	Bar	Mpa	Bar
20°C	68°F	50	9.7	97	11.5	115
60°C	140°F	50	4.9	49	6.1	61
70°C	158°F	50	3.2	32	5.1	51
95°C	203°F	5	1.9	19	3.3	33
110°C	230°F	1	1.9	19	2.6	26

## Hoop Stress v. Time for VIALLI PP-RCT

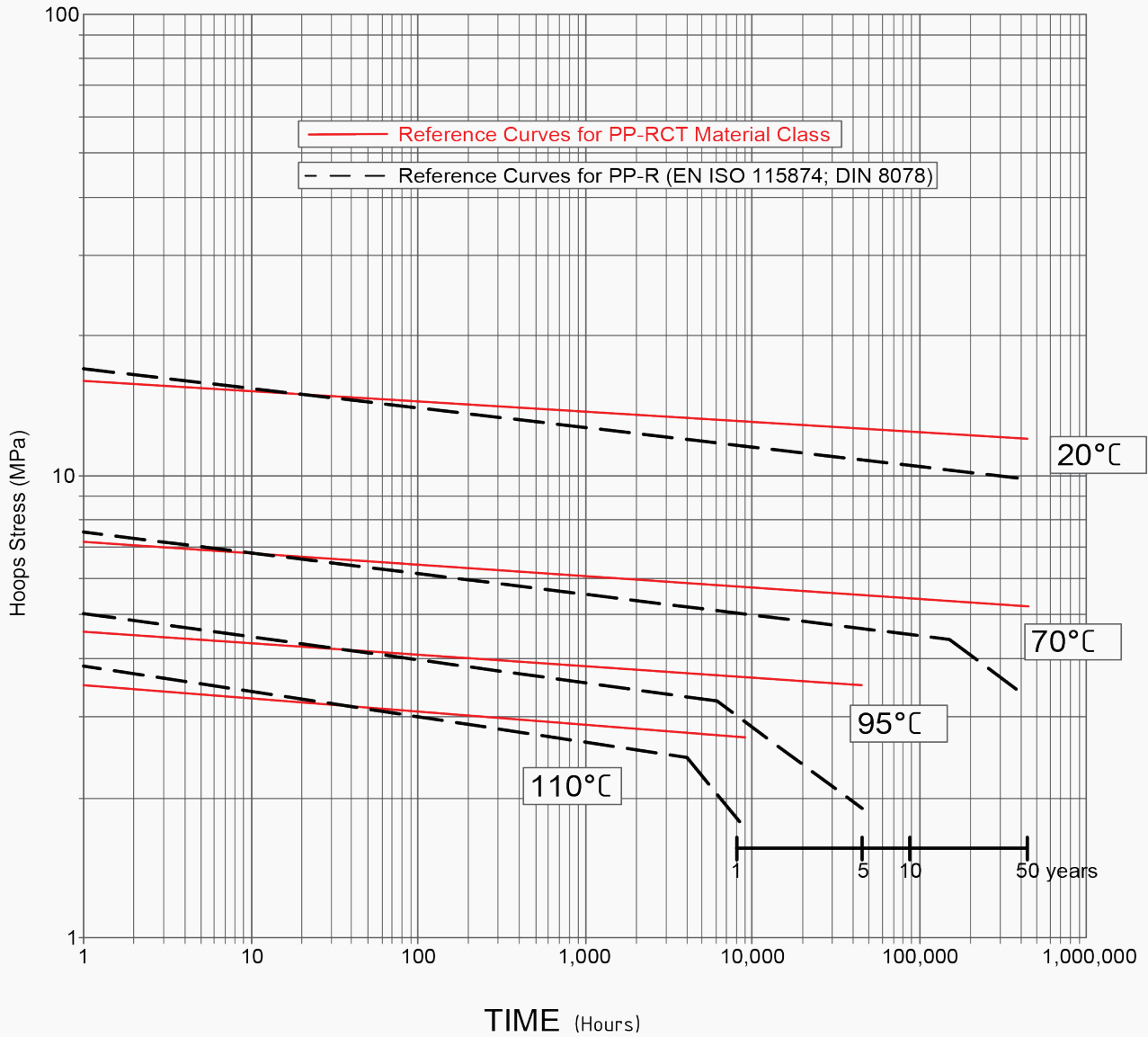

## TYPES OF VIALLI PP-RCT PIPES

### PP-RCT

- 0.15 Thermal Expansion
- Cold and Hot Water Distribution



### PP-RCT with Aluminum Layer

- 3X Less Thermal Expansion (0.045)
- No Need to Shave before Welding
- Cold and Hot Water Distribution



### PP-RCT with Glass Fiber Layer

- 3X Less Thermal Expansion (0.05)
- No Need to Shave before Welding
- Cold and Hot Water Distribution



## PP-RCT THERMAL LINEAR EXPANSION

### Longitudinal expansivity and contractivity

The difference of temperature during installation and under service conditions, i.e., a medium flow through the system at a different temperature to that prevailing during the installation period, results in linear changes – expansion or contraction ( $\Delta$ )

$$\Delta L = \alpha \times L \times \Delta T$$

$\Delta L$  = length change(mm)

$\alpha$  = Coefficient of thermal longitudinal expansion [mm/m°C] for PP-RCT design purposes

$\alpha = 0.15$  for Multilayer Fiber  $\alpha = 0.15$

$L$  = Design distance of fixed points in the line (m)

$\Delta T$  = installation and service temperature

$$L_s = k \cdot \sqrt{d \cdot \Delta L [\text{mm}]}$$

$L_s$  = Compensatory length

$K$  = Material Constant for PPR ( $K = 20$ )

$d$  = Outer Diameter of piping (mm)

$\Delta l$  = longitudinal change (mm) calculated for the previous formula ( $\Delta L = \alpha \cdot L \cdot \Delta T$ )

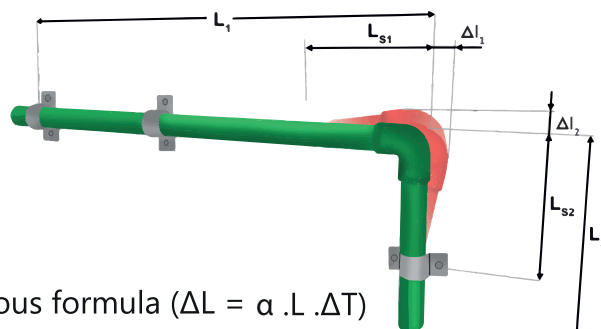

### U – COMPENSATOR

A suitable method for compensating for piping deflection in the direction perpendicular to the original route involves leaving a free compensatory length (designated as "L"). This compensatory length (L) is strategically placed to ensure that significant additional pressure and tensile stress do not arise within the piping wall. The compensatory length (Lk) depends on factors such as the calculated lengthening or shortening of the route, the material used, and the diameter of the piping. In the case of polypropylene, flexibility of the material is utilized for compensating for longitudinal changes. In addition to compensation at bends, "U" compensators and loop compensators are also employed.

**PB** = Fixed point

**Ku** = Sliding point

**L** = Calculating length of the piping

**Ls** = Compensatory length

**Δl** = Longitudinal change (mm) calculated for the previous formula ( $\Delta L = \alpha \cdot L \cdot \Delta T$ )

**Lk** = Width of the compensator

**Lk** = **2 · ΔL + 150 [mm] and also Lk ≥ 10 · D**

**Lk** = With of the compensator

**d** = Outer Diameter of piping (mm)

**Δl** = Longitudinal change (mm)

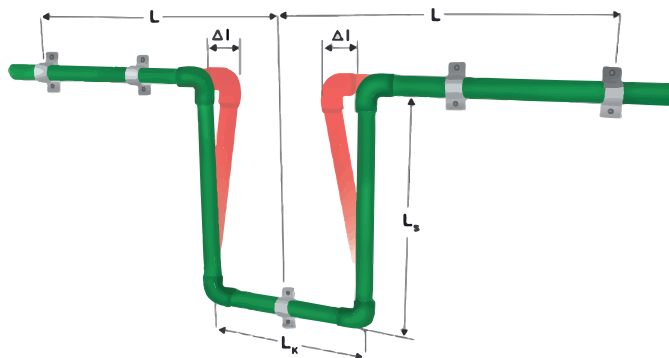

## PP-RCT THERMAL LINEAR EXPANSION

The value of the longitudinal change and the value of the compensatory length can also be read from the graphs.

### Table for installation of a loop compensator

Piping diameter (mm)	Fixed points distance L (m)	
	Faser, Stabi	PPR and PP-RCT
16	24	8
20	27	9
25	30	10
32	36	12
40	42	14

### Loop compensator LC

- PB** = Fixed point
- Ku** = Sliding point
- L** = Calculating length of the piping
- Ls** = Compensatory length
- Lk** = Width of the compensator

An example of compensation by changing the route adapted to the building structure.

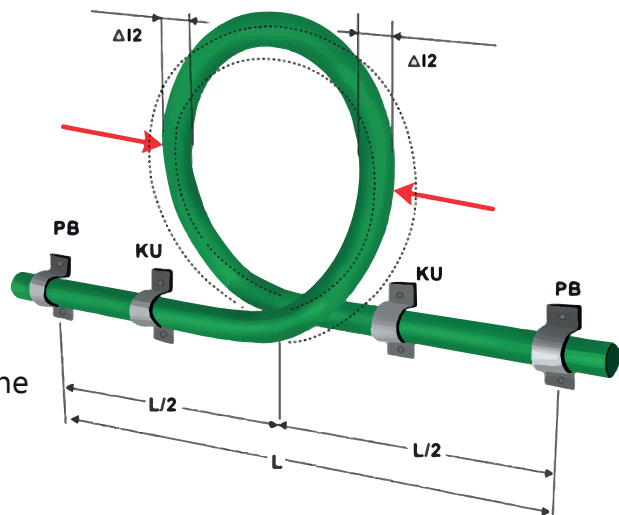

### “U” Compensator

Calculated free length L means the length without any fixed support or suspension which could impede the dilatation. Free length L should not exceed the maximum distance of supports according to the piping diameter and the temperature of the medium.

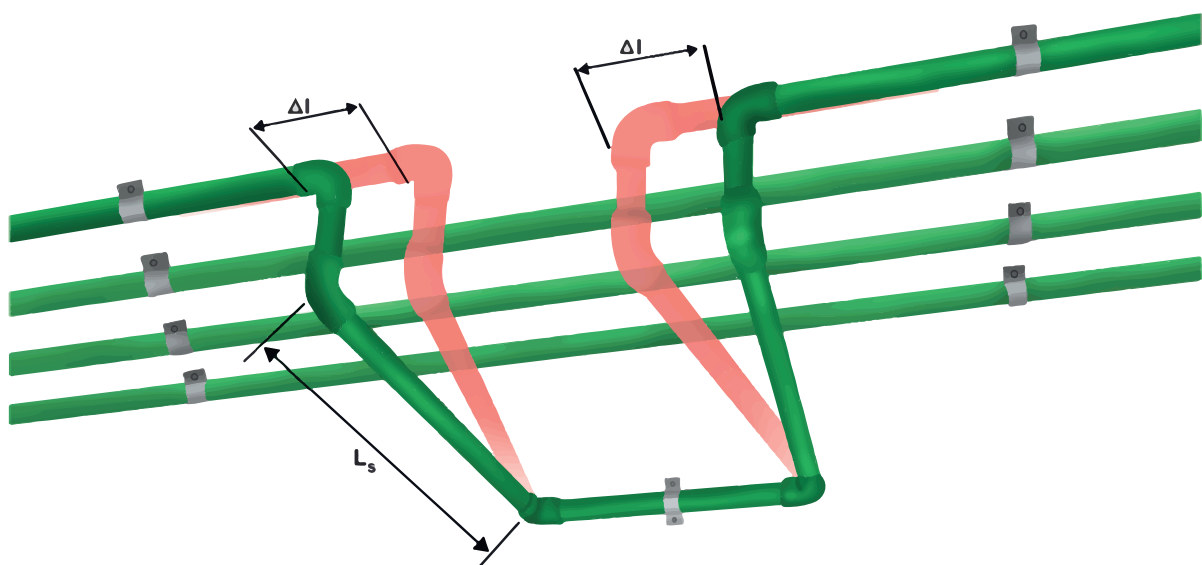

## INSTALLATION RECOMMENDATIONS

---

- Handling the installation VIALLI PP-Rc pipes and fittings does not fundamentally differ from the installation scheme for metallic pipes.
- Fittings and fixtures commonly used in the trade, as well as insulation materials in accordance with heating installation regulations, may be applied in the traditional manner.
- The planning and execution of drinking water systems are conducted in compliance with DIN 1988, which encompasses the "Technical Regulations on Drinking Water Systems."
- It can be used in mixed systems, for example, during repair work without any issues.
- The minimal number of tools needed simplifies the handling of the entire system.
- Owing to the extensive fitting programmed, appropriate molded parts are required for each mode of installation, e.g. wall installations are available.
- Connecting with existing VIALLI systems can be seamlessly accomplished using welding saddles.
- Installations elements subject to frequent use can be pre-assembled (welded) in the workshop.

### **To make sure that our system is installed in a professional manner, the following recommendation should be observed:**

---

- Avoid the presence of bubbles inside the piping.
- Install piping in an upward direction towards the tapping point.
- Place aerators and ventilation devices at the upper end of the ascending part of the line and evacuation points at the lower end.
- Mount separate cut-offs for ascending phases, apartment piping, pressure risers, hot water boilers, and garden piping.
- Always secure pipe fittings with inserts to prevent sound transmission.
- Avoid contact with structural elements when passing pipes through walls and ceilings to eliminate sound transmission.
- Account for pipe elongation when welding, as welding at outdoor temperatures below 0°C is possible only under specific conditions.

## HANDLING GUIDE

Because of the material properties of polypropylene, the pipes and fittings can be stored for a long under temperatures. The storage of pipes and fittings must be in accordance with the following conditions:

- The pipes should be supported along their full length.
- Bending of the pipes to be avoided.
- The material becomes sensitive to impact at low temperatures and in particular at temperature below 0°C, for this reason knocks and similar impacts are to be avoided under these conditions.
- High – polymer materials are sensitive to UV radiation, for this reason the M.P.I. material should also be protected against the effects of UV radiation.

## ON SITE STORAGE AND HANDLING

Incorrect way to load pipes

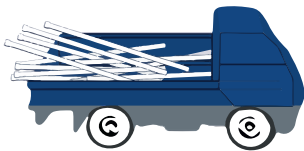

Incorrect way to off load

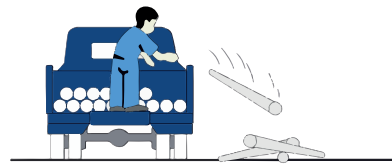

correct way to load pipes

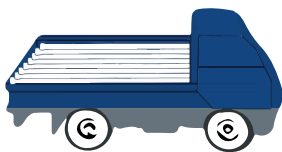

correct way to off load

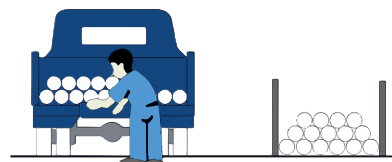

Incorrect way to stack pipes



correct way to stack pipes

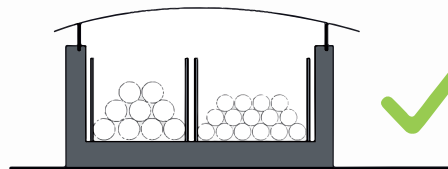
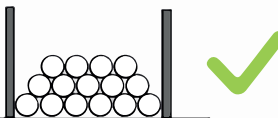



## ASSEMBLY AND INSTALLATION

### GENERAL

Only components not damaged or contaminated either during storage or transport, may be used for installation works.

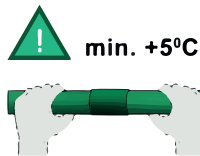

A minimum temperature level for plastic piping installation is with regard to welding, +5°C. At lower temperatures it is difficult to provide working conditions for high quality pipe joints.

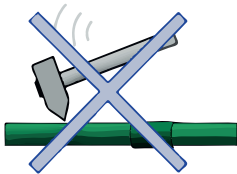

Components of plastic piping system must be protected against damage during transport and installation.

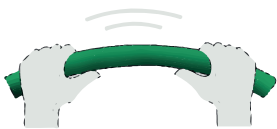

Pipe bending should be done at +15°C for pipes of diameter range 16-32mm. Minimum bending radius equals to eight diameters.



Components must not be exposed to naked flames.

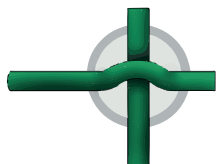

Pipeline cross overs should be made with use of components specially designed for this purpose.

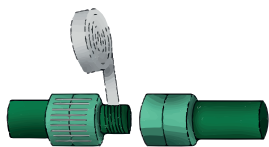

Threaded fittings must be used for screw type joints. Threads should never be cut directly into plastic components. Threads are sealed with a special PTFE tape or sealing compound.

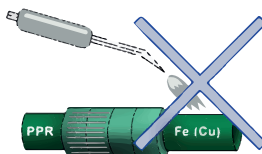

Brazing or soldering of metal fittings should not take place close to joint between metal plastic systems because of potential hazard of heat transfer to the fitting.

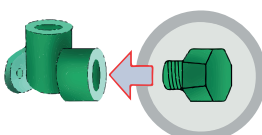

It is recommended to use plastic plugs for blanking elbows or wall mounting groups (plastic plugs are designated only for temporary use). For long term blanking has to be plug with metal thread.

### Definitions, symbols and abbreviations

The criteria of classification, definitions, symbols and abbreviations adopted in this document are as follows:

#### **S = Satisfactory**

The chemical resistance of polypropylene exposed to the action of a fluid is classified as satisfactory when the results of the test are acknowledged to be satisfactory by the majority of the countries participating in the evaluation.

#### **L = Limited**

The chemical resistance of polypropylene exposed to the action of a fluid is classified as limited when the results of test are acknowledged to be limited by the majority of the countries participating in the evaluation.

Also classified as limited is the resistance to the action of chemical fluids for which judgments "S" and "NS" or "L" are pronounced to an equal extent.

#### **NS = Not satisfactory**

The chemical resistance of a polypropylene exposed to the action of a fluid is classified as "not satisfactory" when the results of test are acknowledged to be not satisfactory by the majority of the countries participating in the evaluation.

Also classified as "Not satisfactory" are materials for which judgments "L" and "NS" are pronounced to an equal extent

**Sat. sol Saturated** = aqueous solution, prepared at 20°C Aqueous solution at a concentration higher than 10% but not saturated

**Dil.sol** = Dilute aqueous solution at a concentration equal to lower 10%.

**Work.sol** = Aqueous solution having the usual concentration for industrial use.

Solution concentration reported in the text are expressed as a percentage by mass. The aqueous solutions of sparingly soluble chemicals are considered, as far as chemical action towards polypropylene is concerned, as saturated solutions. In general, common chemical names are used in this document.

The evaluation of chemical resistance of polypropylene is based on PP not subjected to mechanical stress. Polypropylene subjected to mechanical stress may behave differently and show different results.

## CHEMICAL RESISTANCE

---

**VIALLI** piping systems are suitable for a wide variety of process piping applications. However, before determining the suitability of a **VIALLI** piping system for conveying chemicals under pressure, it is crucial to verify that the material is appropriate for use and that the piping system can withstand the chemicals under the concurrent pressure, temperature, and other loads it will encounter.

The chemical resistance table provided in this section offers a general guideline for assessing the suitability of **VIALLI PP-RCT** piping systems. However, chemical resistance depends on numerous specific factors, including the concentration of the chemicals, temperatures, concurrent temperature, pressure, and other internal and external loads applied to the system. Consideration should also be given to factors such as the duration of application (continuous vs. intermittent), steady vs. cyclic loading, the presence of other chemicals mixed with the chemical in question, and compliance with relevant design codes.

While these charts can serve as a general guideline for determining resistance, it is highly recommended to contact the factory for further guidance on any chemical application involving **VIALLI**. Ultimately, the final determination should be made by the engineer in charge of the project or another representative of the owner.

Prior to considering **VIALLI** for any chemical application, consult the factory for the full recommendation base on the complete conditions of the application. Do not rely solely on the recommendation shown in the chart a suitability is based on additional factors including but not limited to pressure, temperature, duration and whether there are any mixtures of chemicals involved.

When considering the installation of **VIALLI PP-RCT** materials that are connected to an existing copper piping system, do not install the **PP-RCT** material in application involving elevated temperatures with aggressive water applications if the velocity of the water in the copper piping exceeds 10ft/second, this can result in the release of copper ions which can result in potential stress cracking in PP piping.

## HEAT LOSS & GAIN

**VIALLI** pipe material is renowned for its excellent insulation characteristics due to its low thermal conductivity value. In contrast, competing metal pipes such as copper, steel, and stainless steel are considered poor insulators. Metal pipe materials are actually known as conductors of heat. By comparing the heat loss/gain charts of bare **VIALLI** pipe to those of metal pipes, the thermal advantages offered by **VIALLI** pipe become evident. With a 50°F delta temperature difference across the pipe, the heat loss/gain of metal pipes is significantly higher compared to that of **VIALLI** pipe.

There are two terms commonly used to describe heat loss within a pipe: K-Factor and R-value. The K-factor, also known as thermal conductivity, measures the number of BTUs per hour passing through a one-inch thick, one-square-foot section of material with a 1°F temperature difference between the two surfaces. A lower K-factor indicates that the material is more suitable for insulation. Typical pipe insulation has a K-factor in the range of 0.021 BTU/hr-ft-°F at 75°F. In contrast, the K-factor of steel is 31 BTU/hr-ft-°F at 75°F, and copper has a K-factor of 227 BTU/hr-ft-°F at 75°F. These values are considerably higher than **VIALLI** pipe, which has a K-Factor of 0.22 W/m·K at 68°F.

The National Commercial & Industrial Insulation Standards Manual defines the R-value as "A measure of the ability to retard heat flow rather than transmit heat." In terms of R-value, the better insulator is the material with the highest R-value.

For flat insulation geometry, the relationship between R-value and K-factor is shown in the first equation below. For cylindrical pipe geometry with equivalent thickness, use the equation shown in the middle box below to determine the R-value, as the outer surface area of the insulation is proportionately greater than the inner surface area. The equivalent thickness represents the insulation thickness of a flat surface that would equal the heat flux at the outer surface of a cylindrical geometry. The relationship between R-value and K-factor for pipe insulation is shown in the equation at the bottom.

### R- Value Equations

$$R - \text{Value} = \frac{\text{Thickness (inches)}}{k - \text{factor (BTU inch / (hrft}^2\text{f))}}$$

$$R - \text{Value} = \frac{\text{Equivalent Thickness (inches)}}{k - \text{factor (BTU inch / (hrft}^2\text{f))}}$$

$r_2$  = Outer Radius,  $r_1$  = Inner Radius

$$\text{Equivalent Thickness} = r_2 \times \ln \left( \frac{r_2}{r_1} \right)$$

## INSULATION

For thermal, technical, physical, and mechanical reasons, usage of plastic threaded coupling is not permissible in sanitary engineering. Plastic threaded couplings may be used, for instance, in provisional distribution systems

### INSULATION

While hot water piping systems and heating systems are insulated to prevent heat loss, cold water pipes are insulated to prevent heat gain and pipe condensation. Insulation of cold water systems is necessary because health regulations require that drinking water temperatures remain below 20°C. Similarly, hot water temperatures must be kept below the upper limit specified by safety standards to prevent scalding, and these temperature limits also help control bacterial growth. In addition to specialized technical solutions like thermal sterilization, maintaining proper circulation and keeping hot water at the required temperature level are crucial for protecting against bacteria such as Legionella pneumophila.

The thickness and type of insulation layers are determined based on the thermal resistance of the chosen insulation system, air humidity in the area of the piping system, and the temperature difference between the room (air) and the flowing water.

The entire piping system, including fittings and valves, must be insulated. It is essential to maintain a minimum insulation layer thickness along both the pipe diameter and the length of the pipeline. This means that insulation types that are cut lengthwise and wrapped around the pipes must be securely sealed after installation, using methods such as adhesives, clamps, or sealing tape.

### MINIMUM THERMAL INSULATION LAYER

#### Example:

Placement/Routing of pipes	Insulation layer thickness • = 0.040 W/mK
Freely laid pipes in unheated areas (basement areas for example)	4mm 9mm
Freely laid pipes in heated areas	4mm
Pipes in crawlways without concurrently running hot water lines	13mm
Pipes in crawlways with concurrently running hot water lines	4mm
Independently running under plaster pipes (in channels)	13mm

#### Note:

- The thickness values must be re-calculated for other thermal characteristic.
- High demanding system (such as in bathroom, bathtub, washing machines, etc.) heat loss in plastic pipes with flowing water can be up to 20% smaller than in metal ones. Another 15% can be save by thorough insulation. In systems with small and/or short-time demand, where pipes are not regularly heated to operating temperatures, the savings will be smaller (only 10%) although up to 20% can be expected at peak demand.
- The insulation layer thickness for hot water systems usually ranges between 9 and 15mm at the value of thermal resistance •=0.040 W/mK

## FLOW RATE vs. VELOCITY

Pipe diameter is a critical factor in the proper design of the VIALLI pipe system. It is recommended to maintain an average flow velocity of 8 feet per second (fps). This ensures energy-efficient pumping, control of noise generation, and the mitigation of water hammer effects on the piping system. Once pipe sizes have been determined, the following equations can be used to calculate the system pressure drop and select the pump motor horsepower.

When determining the frictional pressure loss across a system, it is advisable to incorporate a 20% safety factor. This factor accounts for pipe aging, non-smooth welds, and manufacturing tolerances.

### LEGEND

<b>L</b>	Length of pipe and/or equivalent of pipe fitting (ft)
<b>D</b>	Inside diameter of pipe, (ft)
<b>V</b>	Average flow velocity with in pipe, (ft/s)
<b>g</b>	32.174, Gravitational constant, (ft/s <sup>2</sup> )
<b>f</b>	Friction factor
<b>ε</b>	2.2966E-05, Absolute roughness of polypropylene pipe, (feet)
<b>μ</b>	Absolute viscosity of liquid in pipe, (lbMass / ft-s)
<b>v</b>	Kinematic viscosity of fluid of liquid in pipe, (ft <sup>2</sup> /s)
<b>Re</b>	Reynolds number
<b>p</b>	Density of liquid in pipe, (lbMass / ft-s)
<b>Q</b>	Volumetric flow, (gpm)
<b>C</b>	Valve manufacturer's flow coefficient

The Reynolds number allows the friction factor to be determined. Depending on how large or small the Reynolds number will determine which equation should be used to calculate the friction factor.

For Reynolds Number >4000, the flow condition is considered to be turbulent flow condition. For turbulent flow conditions use the Colebrook equation to calculate the friction factor.

A moody diagram can be used to determine the friction factor as well. It can be used to determine the friction factor in laminar flow conditions, or turbulent flow conditions. Transitional flow conditions, or turbulent flow conditions. To use moody diagram first calculate the Reynolds number and a relative roughness number. Use these numbers with moody diagram to determine the friction factor. An equation for relative roughness is shown below.

$$\frac{1}{\sqrt{f}} = -2. \log_{10} \left( \frac{e}{3.7D} + \frac{2.51}{Re\sqrt{f}} \right)$$

$$\text{Relative Roughness} = \frac{e}{D}$$

$$Re \frac{p \cdot D \cdot V}{\mu} = \frac{V \cdot D}{v}$$

## **Fittings with metal inserts**

The durability of fittings is significantly influenced by their resistance to corrosion. Hence, we utilize various types of metal inserts in the manufacturing of male and female VIALLI fittings, as elaborated below.

### **Stainless Steel Inserts**

- Vialli Stainless Steel Fittings have low Interior surface friction, remain stable under extreme temperatures.
- Vialli Stainless Steel Fittings like the ones link plus installs to be among the most durable option available
- The standard for producing Vialli Stainless Steel PP-Rc Fittings DIN 17440 and DIN 17441
- Life Span for Vialli Stainless Steel PP-Rc fittings under Marin environment 35-50 Years

### **Tin Bronze Inserts**

- Excellent properties of Copper-Tin alloys-Gun Metal of Vialli Bronze PP-Rc Fittings.
- All Bronze Inserts with the following Technical Specifications (CuSn<sub>5</sub> Zn<sub>5</sub>Pb<sub>5</sub>-C), (CuSn<sub>5</sub> Zu<sub>5</sub> Pb<sub>2</sub>-C).
- The lifespan of the Vialli Tin Bronze Fittings under Marine Environments is approximately 30-45 years.

### **DZR Brass Chrome Platted**

- VIALLI DZR Brass Chrome Plated PP-Rc fittings are widely used globally, known for their high quality and competitive pricing.
- The VIALLI DZR Brass Chrome-plated PP-Rc Fittings come with the following technical specifications: (CuZn<sub>39</sub> Pb<sub>2</sub>), (CuZn<sub>39</sub> Pb<sub>3</sub>), (CuZn<sub>40</sub> Pb<sub>2</sub>).
- The Surface Treatment Chrome Plated as Per DIN 259 and BS 2779
- The life Span for Vialli DZR Brass Chrome plated Fittings is approximately 25-35 years.

### **Natural Brass Insert**

- VIALLI Natural Brass fittings are produced with technical specifications similar to Brass with Nickel Plating but without undergoing any surface treatment.
- It represents a less durable alternative.
- Life Span for Vialli Natural Brass PP-Rc Fittings under Marine Environments is approximately 15-20 years.



## Types of Welding

VIALLI offers widest range of joining options of any PP-RCT product line with two primary joining methods and a complete range of fittings sizes. VIALLI can be joined by socket fusion and butt fusion.

### SOCKET FUSION

VIALLI offers socket fusion for full pressure joining with a full range of fittings in ½ inch through 5 inch sizes, joints can be made using hand held tools, and in large sizes with bench-style tools for maximum effectiveness.



### BUTT FUSION

VIALLI offers butt fusion with long spigot fittings starting at 2 inch through 24 inch. Butt fusion is often a more fabrication friendly technique compared to socket fusion in sizes of 2 inch through 5 inch, and customer can take advantage of this feature of the VIALLI system.

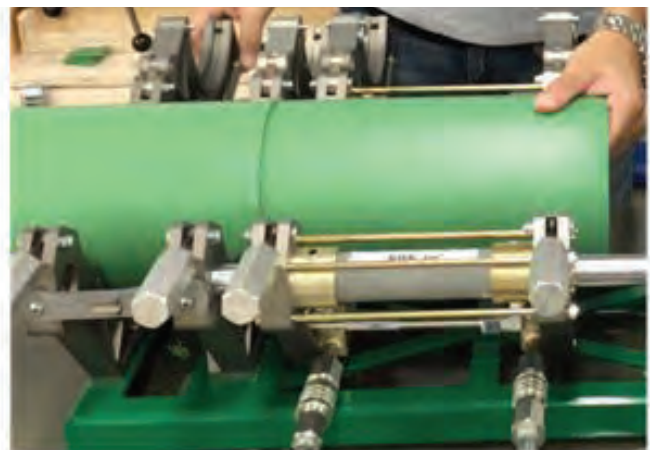



- 1.) Cut the pipe perpendicular to its axis.



- 2.) Heating the pipe and the fitting simultaneously.



- 3.) Within the allowed time interval, connect the pipe and Fitting (do not twist).



- 4.) Ensure that the pipe and fittings are joined with a welding process that is 100% secure.



**Recommended values for welding of PP-Rc pipe at an outdoor temperature of 20 °C & medium air movement (time Requirement)**

1	2	3	4	5	DVS 2207
External pipe Dia. mm	Insert depth mm	Heating period Sec.	Processing period sec.	Cooling period Mins.	
20	14	5	3		With hand welding device
25	15	7	4	2	
32	16.5	8	6	4	
40	18	12	7		
50	20	18	9		
63	24	24	8	6	With welding machine
75	26	30	10	8	
90	32	40	10	8	
110	38.5	50	15	10	
125	40	55	17	12	
160	43	65	20	14	
200	46	72	25	17	
250	50	78	27	20	

# Electrofusion Welding

## 1. Technical Specification and Preparation

- Environment Temperature : - 5°C - +40°C
- Power: 205V – 250V
- Check if the Equipment Function Properly.
- Check if the resistance wires are covered by the inserted pipe or fittings to guarantee a proper working.

### Welding data and cooling time

Dia. (mtm)	System	Welding time (Sec.)	Cooling Time (min)	Ambient Temp (°C)
63-160	Constant Current 5A	80	20	20
200-315	Constant Current 220V	420	30	20

**Note:** If the environment temperature is lower than 20°C, the welding time should extend, if the environment temperature is higher than 20°C the welding time should be shorted. It's not recommended to weld below -5°C or Higher the 40°C. the Cooling time can be reduced by 50% when there is no additional load or strain during cooling.

## 2. Pipe Preparations

### 2.1 Cutting the Pipe.



### 2.2 Measure insertion depth and mark it on the pipe.

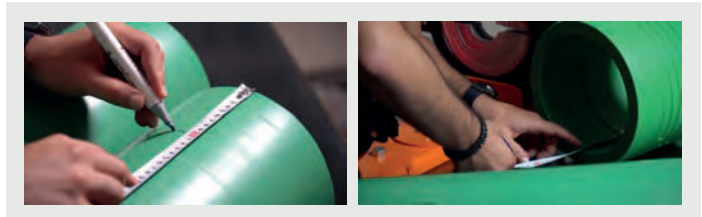

### 2.3 Scrape the outer surface of the pipe (Approx. 0.2mm) to removed oxidized layer and clean after scraping.

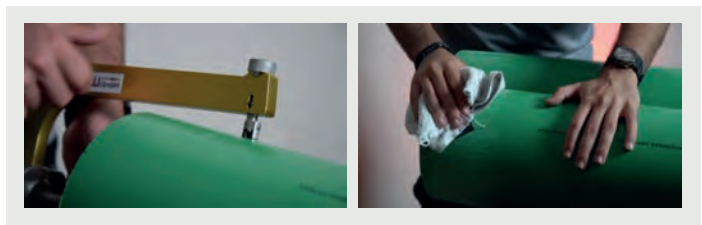

### 2.4 Insertion push the fittings horizontally and up to the marked insertion depth.

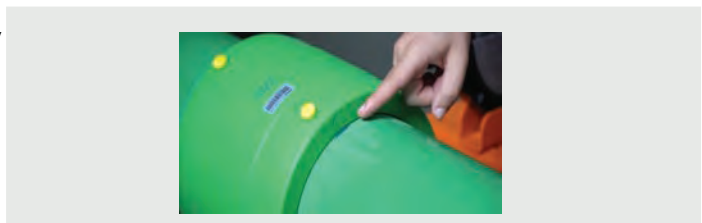

**2.6** Place the pipe fittings on a horizontal frame and ensure that they are fixed properly.

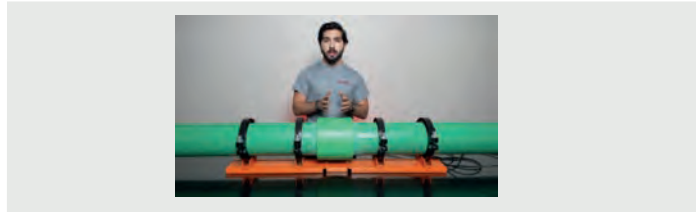

**2.7** Removed the waterproof safety cap, insert the copper head of the welding machine.



**3. Welding Process**

**3.1** Open Electric Fusion welding Machine. The machine interface has three options: Settings, Welding and Printing. First, we will go into Settings to input welding parameters.

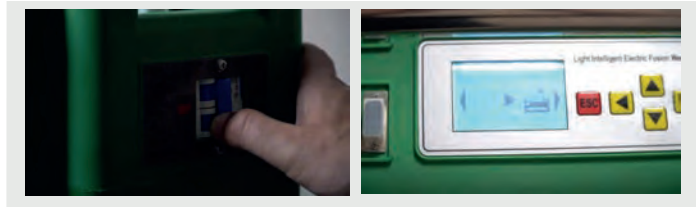

**3.2** Setting welding parameter according to different fitting.

**ESC** : Return Button

**OK** : Confirm Button

**Direction**: Adjust/Movement Button



**There are Two (2) option to setting fusion parameter**

**3.2.1 Option 1 (Manually)**

Manually set the welding parameters on the machine by selecting the setting option and inputting the required parameter according to the requirements.



**3.2.2 Option 2**

Each Fittings has a unique sticker barcode that mentions welding parameters, Use a welding machine scanner to scan the fitting's barcode and input the Parameters into the welding machine automatically.

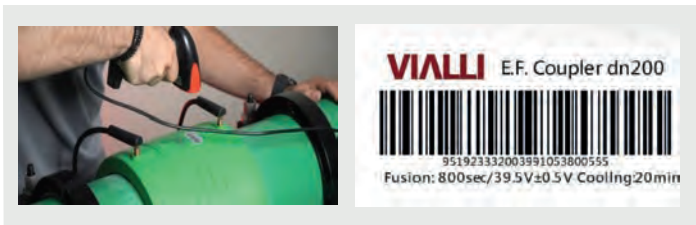

**3.2.3** Finish setting parameter, press ESC button go to main menu, press welding button to check the parameter correctly, finally press OK to start fusion.

- ESC** : Return Button
- OK** : Confirm Button
- Direction**: Adjust/Movement Button

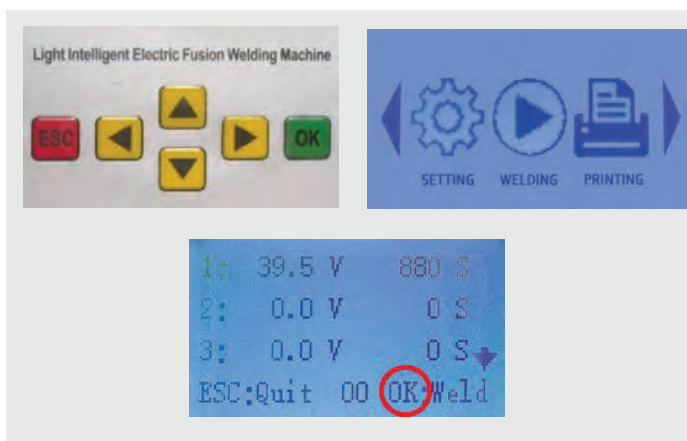

#### 4. Cooling and Inspection of Welding

**4.1** To ensure the welding process is complete, verify that the welding indicator has protruded, signifying that the welding cycle has finished successfully. This indicates that the required heat has been applied and the fusion process is complete.

**4.2** Allow the joint to cool for the specified time on the machine's display. This cooling period is essential to ensure the weld solidifies properly, maintaining the integrity and strength of the joint. During cooling, avoid any movement or external stress on the welded area.

**4.4** Once the cooling time has elapsed, inspect the weld for uniformity and alignment. Only after confirming the integrity of the weld should the system undergo pressure testing or be put into operation.

# VIALLI PRODUCTS

Our products include PP-RCT pipes, PP-R pipes & Fittings designed for indoor cold and hot water distribution systems, floor and central heating systems, air distribution systems, and various applications in industry and agriculture. The lightweight nature of our pipes, coupled with their ease of processing, ensures quick, straightforward, and safe installations. Our welding concept, combined with the low roughness of the internal surface, contributes significantly to minimizing pressure losses in piping distribution systems.



# VIALLI PP-Rc PIPES

## 1.) SDR 7.4 PP-Rc Pipes (Single Layer) PN16

Material: Polypropylene Random Copolymer (PPR)  
 Standards: DIN 8077 / DIN 8078 / DIN 16962 / EN ISO 15874  
 Application: Suitable for hot and cold water distribution.  
 Compound: TYPE - 3  
 Operating Pressure: 20°C/20 bar, 70°C/6 bar.  
 Pipe Length: 4 meters



Size (D)	Inner Dia.	SDR	(S) Wall Thickness	Weight kG/m	Code
----------	------------	-----	--------------------	-------------	------

### SOCKET FUSION / BUTT WELDING

20 mm	14.4 mm	7.4	2.8 mm	0.150	VPPR2016
25 mm	18.0 mm	7.4	3.5 mm	0.238	VPPR2516
32 mm	23.2 mm	7.4	4.4 mm	0.387	VPPR3216
40 mm	29.0 mm	7.4	5.5 mm	0.587	VPPR4016
50 mm	36.2 mm	7.4	6.9 mm	0.900	VPPR5016
63 mm	45.8 mm	7.4	8.6 mm	1.440	VPPR6316
75 mm	54.4 mm	7.4	10.3 mm	1.987	VPPR7516
90mm	65.4 mm	7.4	12.3 mm	2.850	VPPR9016
110 mm	79.8 mm	7.4	15.1 mm	4.335	VPPR11016
160 mm	116.2 mm	7.4	21.9 mm	9.500	VPPR16016

### ELECTROFUSION

200 mm	153.6 mm	9	23.2 mm	12.488	VPPR20016
250 mm	195.4 mm	9	27.3 mm	19.422	VPPR25016
315mm	263.8 mm	11	25.6 mm	24.600	VPPR31516

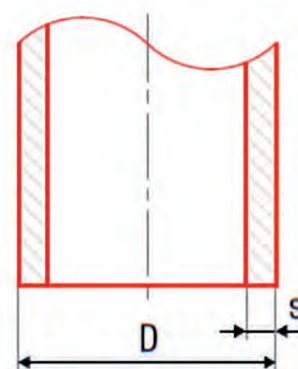

## 2.) SDR 6 PP-Rc Pipes (Single Layer) PN20

Material: Polypropylene Random Copolymer (PPR)  
 Standards: DIN 8077 / DIN 8078 / DIN 16962 / EN ISO 15874  
 Application: Suitable for hot and cold water distribution.  
 Compound: TYPE - 3  
 Operating Pressure: 20°C/20 bar, 70°C/8 bar.  
 Pipe Length: 4 meters



Size (D)	Inner Dia.	SDR	(S) Wall Thickness	Weight kG/m	Code
----------	------------	-----	--------------------	-------------	------

### SOCKET FUSION / BUTT WELDING

20 mm	13.2 mm	6	3.4 mm	0.137	VPPR20
25 mm	16.6 mm	6	4.2 mm	0.216	VPPR25
32 mm	21.2 mm	6	5.4 mm	0.353	VPPR32
40 mm	26.6 mm	6	6.7 mm	0.660	VPPR40
50 mm	33.2 mm	6	8.3 mm	1.054	VPPR50
63 mm	42.0 mm	6	10.5 mm	1.697	VPPR63
75 mm	50.0 mm	6	12.5 mm	2.328	VPPR75
90 mm	60.0 mm	6	15 mm	3.415	VPPR90
110 mm	73.2 mm	6	18.4 mm	5.150	VPPR110
160 mm	106.4 mm	6	26.6 mm	10.600	VPPR160

### ELECTROFUSION

200 mm	143.4 mm	7.4	28.3 mm	16.568	VPPR200
250 mm	183.0 mm	7.4	33.3 mm	25.900	VPPR250

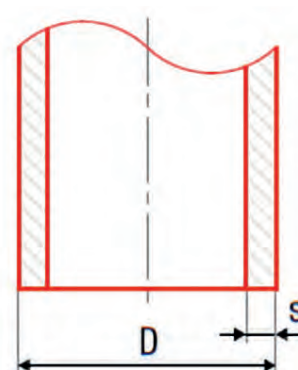

### 3.) SDR 7.4 Multilayer PP-Rc Pipes (Fiber Glass Layer) PN20

Material: Polypropylene Random Copolymer (PPR)  
 Standards: DIN 8077 / DIN 8078 / DIN 16962 / EN ISO 15874  
 Application: Suitable for hot and cold water distribution.  
 Compound: TYPE - 3  
 Operating Pressure: 25°C/20 bar, 70°C/8 bar.  
 Pipe Length: 4 meters



Size (D)	Inner Dia.	SDR	(S) Wall Thickness	Weight kG/m	Code
----------	------------	-----	--------------------	-------------	------

**SOCKET FUSION / BUTT WELDING**

20 mm	14.4 mm	7.4	2.8 mm	0.150	VPPR20FG20
25 mm	18.0 mm	7.4	3.5 mm	0.238	VPPR25FG20
32 mm	23.2 mm	7.4	4.4 mm	0.387	VPPR32FG20
40 mm	29.0 mm	7.4	5.5 mm	0.587	VPPR40FG20
50 mm	36.2 mm	7.4	6.9 mm	0.900	VPPR50FG20
63 mm	45.8 mm	7.4	8.6 mm	1.440	VPPR63FG20
75 mm	54.4 mm	7.4	10.3 mm	1.987	VPPR75FG20
90 mm	65.4 mm	7.4	12.3 mm	2.850	VPPR90FG20
110 mm	79.8 mm	7.4	15.1 mm	4.335	VPPR110FG20
160 mm	116.2 mm	7.4	21.9 mm	9.500	VPPR160FG20

**ELECTROFUSION**

200 mm	153.6 mm	9	23.2 mm	12.488	VPPR200FG20
250 mm	195.4 mm	9	27.3 mm	19.422	VPPR250FG20

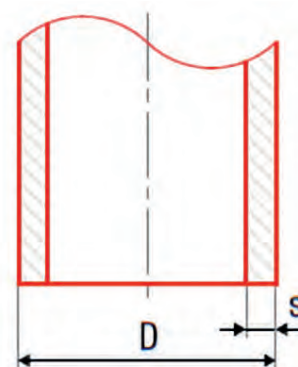

### 4.) SDR 6 Multilayer PP-Rc Pipes (Fiber Glass Layer) PN25

Material: Polypropylene Random Copolymer (PPR)  
 Standards: DIN 8077 / DIN 8078 / DIN 16962 / EN ISO 15874  
 Application: Suitable for hot and cold water distribution.  
 Compound: TYPE - 3  
 Operating Pressure: 25°C/20 bar, 70°C/10 bar.  
 Pipe Length: 4 meters



Size (D)	Inner Dia.	SDR	(S) Wall Thickness	Weight kG/m	Code
----------	------------	-----	--------------------	-------------	------

**SOCKET FUSION / BUTT WELDING**

20 mm	13.2 mm	6	3.4 mm	0.137	VPPR20
25 mm	16.6 mm	6	4.2 mm	0.216	VPPR25
32 mm	21.2 mm	6	5.4 mm	0.353	VPPR32
40 mm	26.6 mm	6	6.7 mm	0.660	VPPR40
50 mm	33.2 mm	6	8.4 mm	1.054	VPPR50
63 mm	42.0 mm	6	10.5 mm	1.697	VPPR63
75 mm	50.0 mm	6	12.5 mm	2.328	VPPR75
90 mm	60.0 mm	6	15 mm	3.415	VPPR90
110 mm	73.2 mm	6	18.4 mm	5.150	VPPR110
160 mm	106.4 mm	6	26.6 mm	10.600	VPPR160

**ELECTROFUSION**

200 mm	143.4 mm	7.4	28.3 mm	16.568	VPPR200
250 mm	183.0 mm	7.4	33.3 mm	25.900	VPPR250

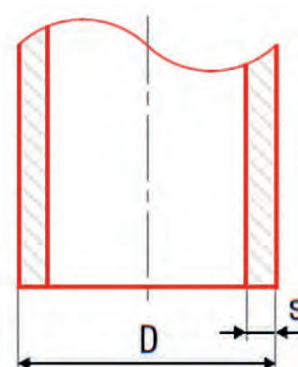

## 5.) SDR 6 Multilayer PP-Rc Pipes (Aluminum Layer) PN25

Material: Polypropylene Random Copolymer (PPR)  
 Standards: DIN 8077 / DIN 8078 / DIN 16962 / EN ISO 15874  
 Application: Suitable for hot and cold water distribution.  
 Compound: TYPE - 3  
 Operating Pressure: 25°C/20 bar, 70°C/10 bar.  
 Pipe Length: 4 meters



Size (D)	Inner Dia.	SDR	(S) Wall Thickness	Weight kG/m	Code
SOCKET FUSION / BUTT WELDING					
20 mm	13.2 mm	6	3.4 mm	0.137	VPPR20A
25 mm	16.6 mm	6	4.2 mm	0.216	VPPR25A
32 mm	21.2 mm	6	5.4 mm	0.353	VPPR32A
40 mm	26.6 mm	6	6.7 mm	0.660	VPPR40A
50 mm	33.2 mm	6	8.4 mm	1.054	VPPR50A
63 mm	42.0 mm	6	10.5 mm	1.697	VPPR63A
75 mm	50.0 mm	6	12.5 mm	2.328	VPPR75A
90 mm	60.0 mm	6	15.0 mm	3.415	VPPR90A
110 mm	73.2 mm	6	18.4 mm	5.150	VPPR110A

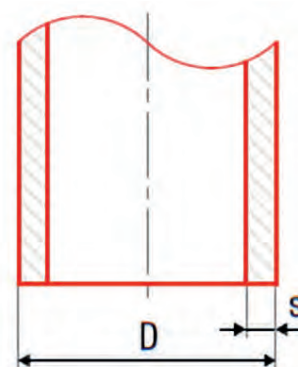

## 6.) SDR 7.4 Multilayer UV PP-Rc Pipes (Fiber Glass Layer) PN20

Material : Polypropylene Random Copolymer (PPR)  
 Standards: DIN 8077 / DIN 8078 / DIN 16962 / EN ISO 15874  
 Application : Suitable for hot and cold water distribution.  
 Compound : TYPE - 3  
 Operating Pressure : 25°C/20 bar, 70°C/8 bar.  
 Pipe Length : 4 meters



Size (D)	Inner Dia.	SDR	(S) Wall Thickness	Weight kG/m	Code
SOCKET FUSION / BUTT WELDING					
20 mm	14.4 mm	7.4	2.8 mm	0.150	VPPR20FG20UV
25 mm	18.0 mm	7.4	3.5 mm	0.238	VPPR25FG20UV
32 mm	23.2 mm	7.4	4.4 mm	0.387	VPPR32FG20UV
40 mm	29.0 mm	7.4	5.5 mm	0.587	VPPR40FG20UV
50 mm	36.2 mm	7.4	6.9 mm	0.900	VPPR50FG20UV
63 mm	45.8 mm	7.4	8.6 mm	1.440	VPPR63FG20UV
75 mm	54.4 mm	7.4	10.3 mm	1.987	VPPR75FG20UV
90 mm	65.4 mm	7.4	12.3 mm	2.850	VPPR90FG20UV
110 mm	79.8 mm	7.4	15.1 mm	4.335	VPPR110FG20UV

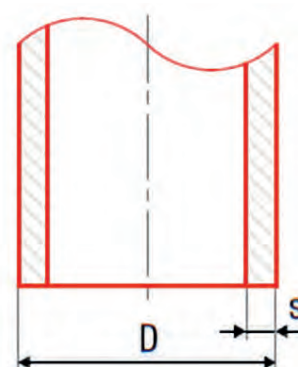



## 7.) SDR 6 Multilayer UV PP-Rc Pipes (Fiber Glass Layer) PN25

Material: Polypropylene Random-Copolymer Temperature Resistant (PP-RCT)

Standards: DIN 8077 / DIN 8078 / DIN 16962 / EN ISO 15874

Application: Suitable for hot and cold water distribution.

Compound: TYPE - 4

Operating Pressure: 20°C/20 bar, 70°C/10 bar.

Pipe Length: 4 meters



Size (D)	Inner Dia.	SDR	(S) Wall Thickness	Weight kG/m	Code
SOCKET FUSION / BUTT WELDING					
20 mm	13.2 mm	6	3.4 mm	0.150	VPPR20FG20UV
25 mm	16.6 mm	6	4.2 mm	0.238	VPPR25FG20UV
32 mm	21.2 mm	6	5.4 mm	0.387	VPPR32FG20UV
40 mm	26.6 mm	6	6.7 mm	0.587	VPPR40FG20UV
50 mm	33.2 mm	6	8.4 mm	0.900	VPPR50FG20UV
63 mm	42.0 mm	6	10.5 mm	1.440	VPPR63FG20UV
75 mm	50.0 mm	6	12.5 mm	1.987	VPPR75FG20UV
90 mm	60.0 mm	6	15 mm	2.850	VPPR90FG20UV
110 mm	73.2 mm	6	18.4 mm	4.335	VPPR110FG20UV

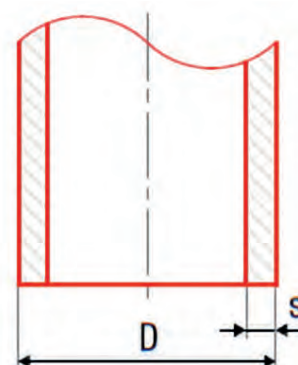

# VIALLI PP-RCT PIPES

## 1.) VIALLI PP-RCT Pipes Single Layer SDR 9/SDR 11

Material: Polypropylene Random-Copolymer Temperature Resistant (PP-RCT)

Standard: EN ISO 15874 / DIN 8077 / DIN 8078

Application: Suitable for hot and cold water distribution.

Compound: TYPE - 4

Operating Pressure: 20°C/20 bar, 70°C/10 bar.

Pipe Length: 4 meters

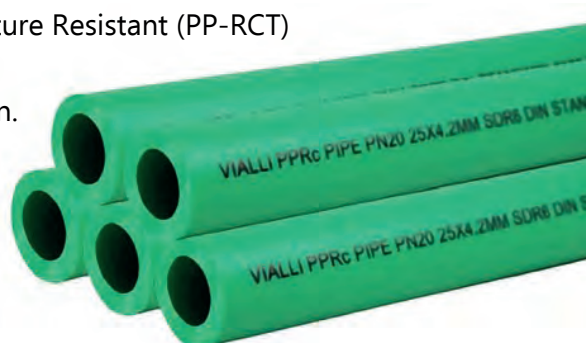

Size(O.D)	Inner Dia.	SDR	(S) Wall Thickness	Code
20 mm	15.4 mm	9	2.3 mm	VPPRCT2016
25 mm	19.4 mm	9	2.8 mm	VPPRCT2516
32 mm	26.2 mm	11	2.9 mm	VPPRCT3216
40 mm	32.6 mm	11	3.7 mm	VPPRCT4016
50 mm	40.8 mm	11	4.6 mm	VPPRCT5016
63 mm	51.4 mm	11	5.8 mm	VPPRCT6316
75 mm	61.4 mm	11	6.8 mm	VPPRCT7516
90 mm	73.6 mm	11	8.2 mm	VPPRCT9016
110 mm	90.0 mm	11	10.0 mm	VPPRCT11016
160 mm	130.8 mm	11	14.6 mm	VPPRCT16016
200 mm	163.3 mm	11	18.2 mm	VPPRCT20016
250 mm	204.6 mm	11	22.7 mm	VPPRCT25016

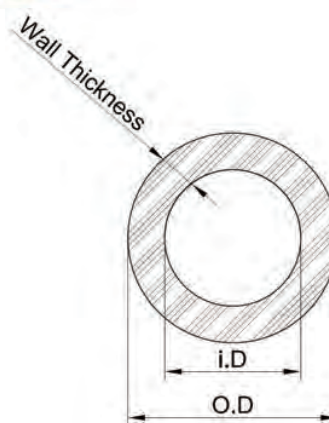

## 2.) VIALLI PP-RCT Pipes Single Layer SDR 7.4

Material: Polypropylene Random-Copolymer Temperature Resistant (PP-RCT)

Standard: EN ISO 15874 / DIN 8077 / DIN 8078

Application: Suitable for hot and cold water distribution.

Compound: TYPE - 4

Operating Pressure: 20°C/20 bar, 70°C/10 bar.

Pipe Length: 4 meters

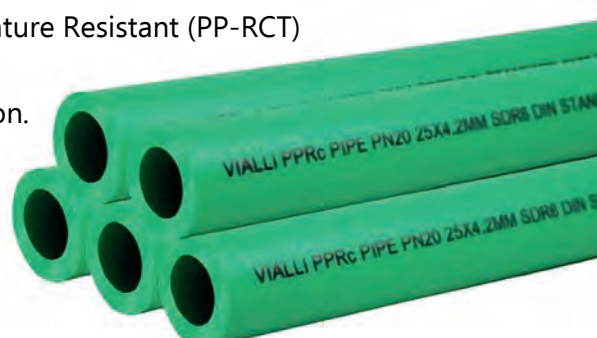

Size(O.D)	Inner Dia.	SDR	(S) Wall Thickness	Code
20 mm	14.4 mm	7.4	2.8mm	2.8 mm
25 mm	18.0 mm	7.4	3.5mm	3.5 mm
32 mm	23.2 mm	7.4	4.4mm	4.4 mm
40 mm	29.0 mm	7.4	5.5mm	5.5 mm
50 mm	36.2 mm	7.4	6.9mm	6.9 mm
63 mm	45.8 mm	7.4	8.6mm	8.6 mm
75 mm	54.4 mm	7.4	10.3mm	10.3 mm
90 mm	65.4 mm	7.4	12.3mm	12.3 mm
110 mm	79.8 mm	7.4	15.1mm	15.1 mm

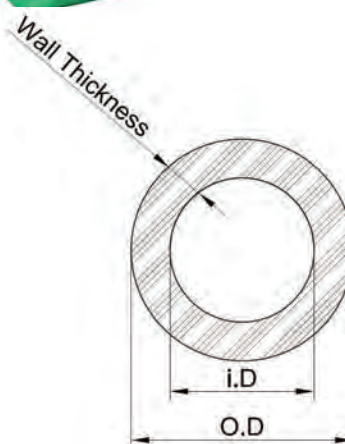

### 3.) VIALLI PP-RCT Pipes Multi Layer Aluminum Composite SDR 7.4/SDR 9

Material: Polypropylene Random-Copolymer Temperature Resistant (PP-RCT)

Standard: EN ISO 15874 / DIN 8077 / DIN 8078

Application: Suitable for hot and cold water distribution.

Compound: TYPE - 4

Operating Pressure: 20°C/20 bar, 70°C/10 bar.

Pipe Length: 4 meters



Size(O.D)	Inner Dia.	SDR	(S) Wall Thickness	Code
20 mm	14.4 mm	7.4	2.8 mm	VPPRCT20AU
25 mm	18.0 mm	9	2.8 mm	VPPRCT25AU
32 mm	23.2 mm	9	3.6 mm	VPPRCT32AU
40 mm	29.0 mm	9	4.5 mm	VPPRCT40AU
50 mm	36.2 mm	9	5.6 mm	VPPRCT50AU
63 mm	45.8 mm	9	7.1 mm	VPPRCT63AU
75 mm	54.4 mm	9	8.4 mm	VPPRCT75AU
90 mm	65.4 mm	7.4	12.3 mm	VPPRCT90AU
110 mm	79.8 mm	7.4	15.1 mm	VPPRCT110AU

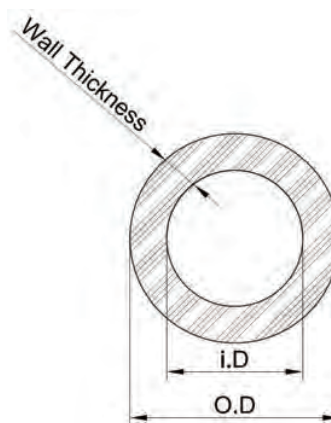

### 4.) VIALLI PP-RCT Pipes Multi Layer Fiber Glass SDR 7.4/SDR 11

Material: Polypropylene Random-Copolymer Temperature Resistant (PP-RCT)

Standard: EN ISO 15874 / DIN 8077 / DIN 8078

Application: Suitable for hot and cold water distribution.

Compound: TYPE - 4

Operating Pressure: 20°C/20 bar, 70°C/10 bar.

Pipe Length: 4 meters

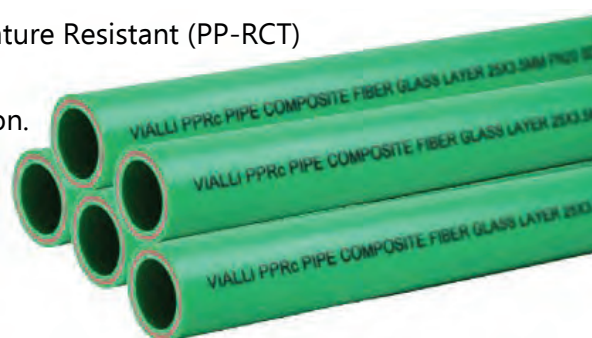

Size(O.D)	Inner Dia.	SDR	(S) Wall Thickness	Code
20 mm	14.4 mm	7.4	2.8 mm	VPPRCT20FG
25 mm	18.0 mm	7.4	3.5 mm	VPPRCT25FG
32 mm	23.2 mm	7.4	4.4 mm	VPPRCT32FG
40 mm	29.0 mm	7.4	5.5 mm	VPPRCT40FG
50 mm	36.2 mm	7.4	6.9 mm	VPPRCT50FG
63 mm	45.8 mm	7.4	8.6 mm	VPPRCT63FG
75 mm	54.4 mm	7.4	10.3 mm	VPPRCT75FG
90 mm	65.4 mm	7.4	12.3 mm	VPPRCT90FG
110 mm	79.8 mm	7.4	15.1 mm	VPPRCT110FG
160 mm	130.8 mm	11	14.6 mm	VPPRCT160FG
200 mm	163.6 mm	11	18.2 mm	VPPRCT200FG
250 mm	204.6 mm	11	22.7 mm	VPPRCT250FG

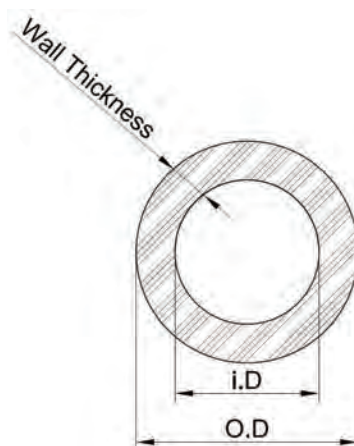

## 5.) VIALLI PP-RCT UV Pipes Multi-Layer Glass Fiber SDR 7.4

Material: Polypropylene Random-Copolymer Temperature Resistant (PP-RCT)

Standard: EN ISO 15874 / DIN 8077 / DIN 8078

Application: Suitable for hot and cold water distribution.

Compound: TYPE - 4

Operating Pressure: 20°C/20 bar, 70°C/10 bar.

Pipe Length: 4 meters

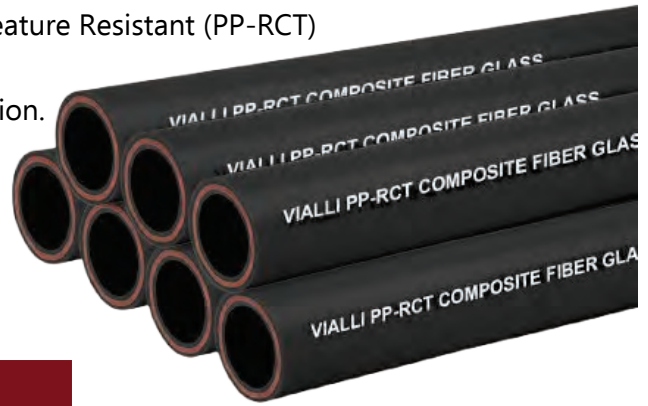

Size(O.D)	Inner Dia.	SDR	(S) Wall Thickness	Code
20 mm	13.2 mm	6	3.4 mm	VPPRCT20FGUV
25 mm	16.6 mm	6	4.2 mm	VPPRCT25FGUV
32 mm	21.2 mm	6	5.4 mm	VPPRCT32FGUV
40 mm	26.6 mm	6	6.7 mm	VPPRCT40FGUV
50 mm	33.2 mm	6	8.4 mm	VPPRCT50FGUV
63 mm	42.0 mm	6	10.5 mm	VPPRCT63FGUV
75 mm	50.0 mm	6	12.5 mm	VPPRCT75FGUV
90 mm	60.0 mm	6	15m m	VPPRCT90FGUV
110 mm	73.2 mm	6	18.4 mm	VPPRCT110FGUV
160 mm	106.4 mm	6	26.6 mm	VPPRCT160FGUV
200 mm	143.4 mm	7.4	28.3 mm	VPPRCT200FGUV
250 mm	183.0 mm	7.4	33.3 mm	VPPRCT250FGUV

# VIALLI FITTINGS

## 1.) Equal Socket

Size (D)	Description	CODE
----------	-------------	------

### SOCKET FUSION

20mm	Equal Socket	VS1
25mm	Equal Socket	VS2
32mm	Equal Socket	VS3
40mm	Equal Socket	VS4
50mm	Equal Socket	VS5
63mm	Equal Socket	VS6
75mm	Equal Socket	VS7
90mm	Equal Socket	VS9
110mm	Equal Socket	VS10
160mm	Equal Socket	VS16
200mm	Equal Socket	VS20
250mm	Equal Socket	VS25

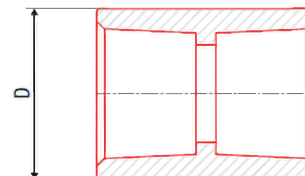

## 2.) Equal Tee

Size (D)	Description	CODE
----------	-------------	------

### SOCKET FUSION

20x20x20mm	Equal Tee	VT1
25x25x25mm	Equal Tee	VT2
32x32x32mm	Equal Tee	VT3
40x40x40mm	Equal Tee	VT4
50x50x50mm	Equal Tee	VT5
63x63x63mm	Equal Tee	VT6
75x75x75mm	Equal Tee	VT7
90x90x90mm	Equal Tee	VT9
110x110x110mm	Equal Tee	VT10
160x160x160mm	Equal Tee	VT16
200x200x200mm	Equal Tee	VT20
250x250x250mm	Equal Tee	VT25

### BUTT WELDING

315x315x315mm	Equal Tee	VT315BW
---------------	-----------	---------

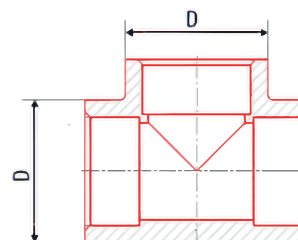
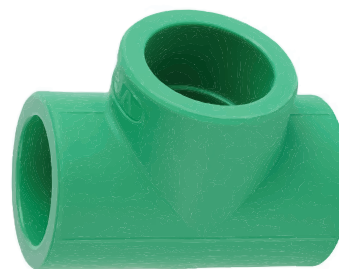

## 3.) Elbow 90°

Size (D)	Description	CODE
----------	-------------	------

### SOCKET FUSION

20mm	Elbow 90°	VE190
25mm	Elbow 90°	VE290
32mm	Elbow 90°	VE390
40mm	Elbow 90°	VE490
50mm	Elbow 90°	VE590
63mm	Elbow 90°	VE690
75mm	Elbow 90°	VE790
90mm	Elbow 90°	VE990
110mm	Elbow 90°	VE1090
160mm	Elbow 90°	VE1690
200mm	Elbow 90°	VE2090
250mm	Elbow 90°	VE2590

### BUTT WELDING

350mm	Elbow 90°	VE31590B
-------	-----------	----------

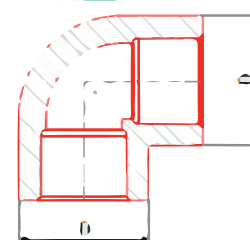

## 4.) Reducer Socket

Size (D)	Description	CODE
----------	-------------	------

### SOCKET FUSION

25/20mm	Reducer Socket	VRS21
32/20mm	Reducer Socket	VRS31
32/25mm	Reducer Socket	VRS32
40/20mm	Reducer Socket	VRS41
40/25mm	Reducer Socket	VRS42
40/32mm	Reducer Socket	VRS43
50/25mm	Reducer Socket	VRS52
50/32mm	Reducer Socket	VRS53
50/40mm	Reducer Socket	VRS54
63/25mm	Reducer Socket	VRS62
63/32mm	Reducer Socket	VRS63
63/40mm	Reducer Socket	VRS64
63/50mm	Reducer Socket	VRS65
75/20mm	Reducer Socket	VRS71
75/25mm	Reducer Socket	VRS72
75/32mm	Reducer Socket	VRS73
75/40mm	Reducer Socket	VRS74
75/50mm	Reducer Socket	VRS75
75/63mm	Reducer Socket	VRS76
90/32mm	Reducer Socket	VRS93
90/40mm	Reducer Socket	VRS94
90/50mm	Reducer Socket	VRS96
90/63mm	Reducer Socket	VRS96
90/75mm	Reducer Socket	VRS97
110/40mm	Reducer Socket	VRS104
110/50mm	Reducer Socket	VRS105
110/63mm	Reducer Socket	VRS106
110/75mm	Reducer Socket	VRS107
110/90mm	Reducer Socket	VRS109
160/110mm	Reducer Socket	VRS1610
200/90mm	Reducer Socket	VRS209
200/110mm	Reducer Socket	VRS2010
200/160mm	Reducer Socket	VRS2016
250/160mm	Reducer Socket	VRS2510
250/200mm	Reducer Socket	VRS2520

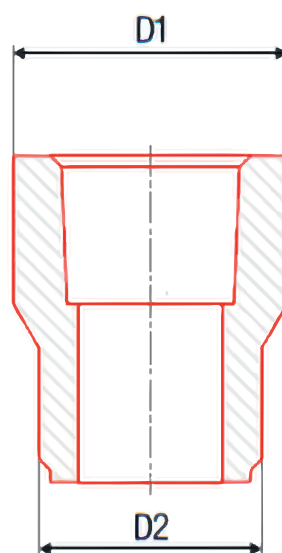

## 5.) Pipe Bridge

Size (D)	Description	CODE
----------	-------------	------

### SOCKET FUSION

20mm	Pipe Bridge	VB1
25mm	Pipe Bridge	VB2
32mm	Pipe Bridge	VB3



## 6.) Elbow 45°

Size (D)	Description	CODE
----------	-------------	------

### SOCKET FUSION

20mm	Elbow 45°	VE145
25mm	Elbow 45°	VE245
32mm	Elbow 45°	VE345
40mm	Elbow 45°	VE445
50mm	Elbow 45°	VE545
63mm	Elbow 45°	VE645
75mm	Elbow 45°	VE745
90mm	Elbow 45°	VE945
110mm	Elbow 45°	VE1045
160mm	Elbow 45°	VE1645
200mm	Elbow 45°	VE2045
250mm	Elbow 45°	VE2545

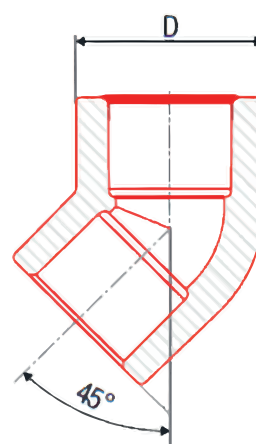

## 7.) End Cap

Size (D)	Description	CODE
----------	-------------	------

### SOCKET FUSION

20mm	End Cap	VEC1
25mm	End Cap	VEC2
32mm	End Cap	VEC3
40mm	End Cap	VEC4
50mm	End Cap	VEC5
63mm	End Cap	VEC6
75mm	End Cap	VEC7
90mm	End Cap	VEC9
110mm	End Cap	VEC10
160mm	End Cap	VEC16
200mm	End Cap	VEC20
250mm	End Cap	VEC25

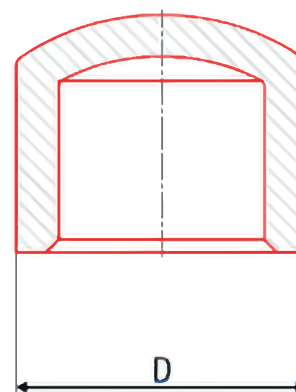

## 8.) Reducer Tee

Size (D)	Description	CODE
----------	-------------	------

### SOCKET FUSION

25x20x25mm	Reducer Tee	VRT212
32x25x32mm	Reducer Tee	VRT323
32x20x32mm	Reducer Tee	VRT313
40x20x40mm	Reducer Tee	VRT414
40x25x40mm	Reducer Tee	VRT424
40x32x40mm	Reducer Tee	VRT434
50x20x50mm	Reducer Tee	VRT515
50x25x50mm	Reducer Tee	VRT525
50x32x50mm	Reducer Tee	VRT535
50x40x50mm	Reducer Tee	VRT545
63x25x63mm	Reducer Tee	VRT626
63x32x63mm	Reducer Tee	VRT636
63x40x63mm	Reducer Tee	VRT646
63x50x63mm	Reducer Tee	VRT656
75x25x75mm	Reducer Tee	VRT727
75x32x75mm	Reducer Tee	VRT737
75x40x75mm	Reducer Tee	VRT747
75x50x75mm	Reducer Tee	VRT757
75x63x75mm	Reducer Tee	VRT767
90x40x90mm	Reducer Tee	VRT949
90x50x90mm	Reducer Tee	VRT959
90x63x90mm	Reducer Tee	VRT969
90x75x90mm	Reducer Tee	VRT979
110x40x110mm	Reducer Tee	VRT10410
110x50x110mm	Reducer Tee	VRT10510
110x63x110mm	Reducer Tee	VRT10610
110x75x110mm	Reducer Tee	VRT10710
110x90x110mm	Reducer Tee	VRT10910
160x110x160mm	Reducer Tee	VRT161016

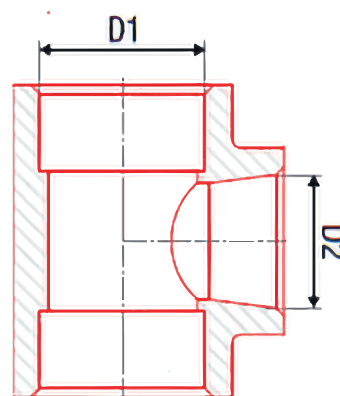

## 9.) Female Adaptor (NON – HEXAGONAL)

Size (D)	Description	CODE
----------	-------------	------

### SOCKET FUSION

20x 1/2"	Female Adaptor	VFA10
25x 1/2"	Female Adaptor	VFA20
25x 3/4"	Female Adaptor	VFA21
32x 1/2"	Female Adaptor	VFA30
32x 3/4"	Female Adaptor	VFA31
32x 1"	Female Adaptor	VFA32
40x 1 1/4"	Female Adaptor	VFA43
50x 1 1/2"	Female Adaptor	VFA54
63x 2"	Female Adaptor	VFA65
75x 2 1/2"	Female Adaptor	VFA76
90x 3"	Female Adaptor	VFA97
110x 4"	Female Adaptor	VFA108

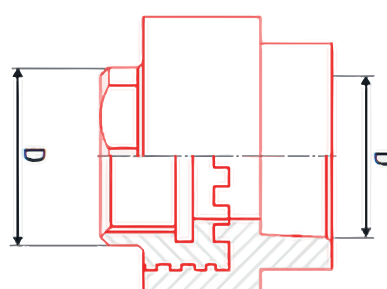



## 10.) Female Adaptor (HEXAGONAL)

Size (D)	Description	CODE
----------	-------------	------

### SOCKET FUSION

32x 1"	Female Adaptor	VFA32
40x 1 ¼"	Female Adaptor	VFA43
50x 1 ½"	Female Adaptor	VFA54
63x 2"	Female Adaptor	VFA65
75x 2 ½"	Female Adaptor	VFA76
90x 3"	Female Adaptor	VFA97
110x 4"	Female Adaptor	VFA108

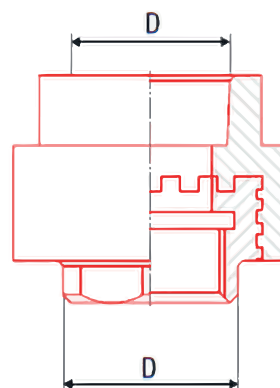

## 11.) Female Elbow 90°

Size (D)	Description	CODE
----------	-------------	------

### SOCKET FUSION

20x ½"	Female Elbow	VFE10
25x ½"	Female Elbow	VFE20
25x ¾"	Female Elbow	VFE21
32x ½"	Female Elbow	VFE30
32x ¾"	Female Elbow	VFE31
32x 1"	Female Elbow	VFE32

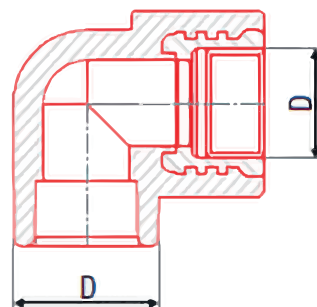

## 12.) Male Adaptor (NON – HEXAGONAL)

Size (D)	Description	CODE
----------	-------------	------

### SOCKET FUSION

20x ½"	Male Adaptor	VMA10
25x ½"	Male Adaptor	VMA20
25x ¾"	Male Adaptor	VMA21
32x ½"	Male Adaptor	VMA30
32x ¾"	Male Adaptor	VMA31

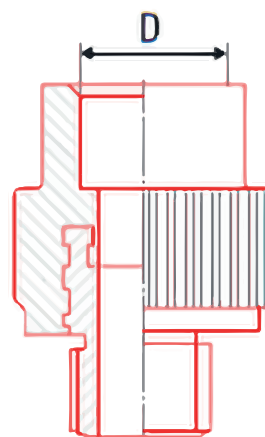

## 13.) Male Adaptor (HEXAGONAL)

Size (D)	Description	CODE
----------	-------------	------

### SOCKET FUSION

32x 1"	Male Adaptor	VMA32
40x 1 ¼"	Male Adaptor	VMA43
50x 1 ½"	Male Adaptor	VMA54
63x 2"	Male Adaptor	VMA65
75x 2 ½"	Male Adaptor	VMA76
90x 3"	Male Adaptor	VMA97
110x 4"	Male Adaptor	VMA108

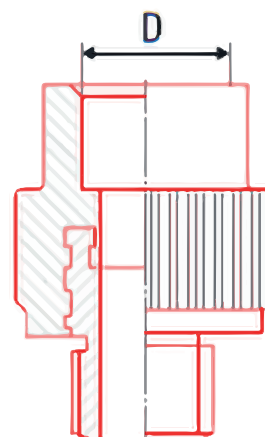

## 14.) Female Tee

Size (D)	Description	CODE
----------	-------------	------

SOCKET FUSION

20x 1/2"x20	Female Tee	VFT10
25x 1/2"x25	Female Tee	VFT20
25x 3/4"x25	Female Tee	VFT21
32x 1/2"x32	Female Tee	VFT30
32x 3/4"x32	Female Tee	VFT31
32x1"x32	Female Tee	VFT32

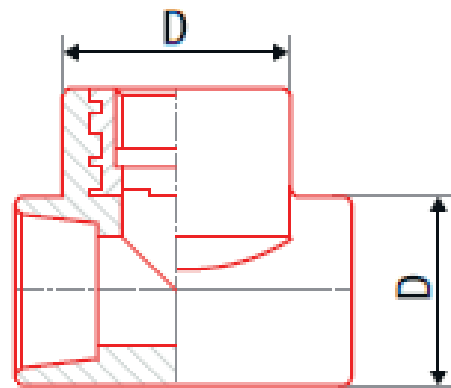

## 15.) Female Union

Size (D)	Description	CODE
----------	-------------	------

SOCKET FUSION

25x 3/4"	Female Union	VFU25
32x1"	Female Union	VFU32
40x1 1/4"	Female Union	VFU43
50x 1 1/2"	Female Union	VFU54
63x2"	Female Union	VFU65

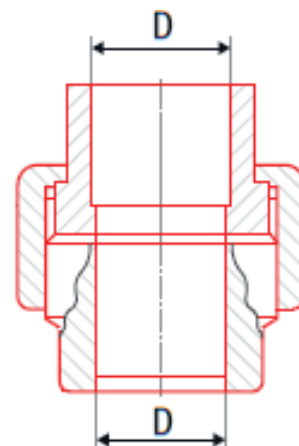

## 16.) Male Union

Size (D)	Description	CODE
----------	-------------	------

### SOCKET FUSION

20x 1/2"	Male Union	VMU10
25x 3/4"	Male Union	VMU21
32x1"	Male Union	VMU32
40x1 1/4"	Male Union	VMU43
50x 1 1/2"	Male Union	VMU54
63x2"	Male Union	VMU65
75x2 1/2"	Male Union	VMU76

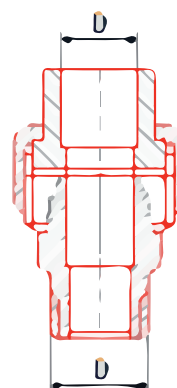

## 17.) Union Socket – Metal

Size (D)	Description	CODE
----------	-------------	------

### SOCKET FUSION

20mm	Union Socket	VUS20
25mm	Union Socket	VUS25
32mm	Union Socket	VUS32
40mm	Union Socket	VUS40M
50mm	Union Socket	VUS50M
63mm	Union Socket	VUS63M
75mm	Union Socket	VUS75M

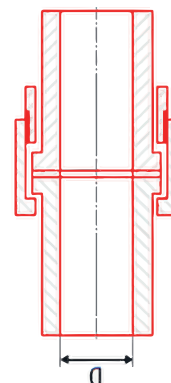

## 18.) Stainless Steel Non-Rising Stem Valve

Size (D)	Description	CODE
----------	-------------	------

SOCKET FUSION

20mm	S.S Non-Rising Stem Valve	VSSV1
25mm	S.S Non-Rising Stem Valve	VSSV2
32mm	S.S Non-Rising Stem Valve	VSSV3
40mm	S.S Non-Rising Stem Valve	VSSV4
50mm	S.S Non-Rising Stem Valve	VSSV5
63mm	S.S Non-Rising Stem Valve	VSSV6

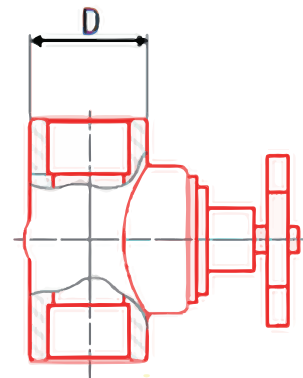

## 19.) Chrome Plated Valve

Size (D)	Description	CODE
----------	-------------	------

SOCKET FUSION

20mm	Chrome Plated Valve	VCV1
25mm	Chrome Plated Valve	VCV2
32mm	Chrome Plated Valve	VCV3

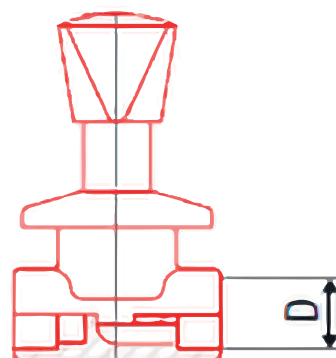

## 20.) Pipe Clamp

Size (D)	Description	CODE
----------	-------------	------

### SOCKET FUSION

20 mm	Pipe Clamp	VPC1
25 mm	Pipe Clamp	VPC2
32 mm	Pipe Clamp	VPC3
40 mm	Pipe Clamp	VPC4

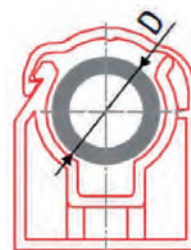

## 21.) Test Plug

Size (D)	Description	CODE
1/2"	Test Plug	VPTP0

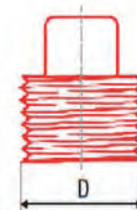

## 22.) Flange Set

Size (D)	Description	CODE
----------	-------------	------

### SOCKET FUSION

63 mm	Flange Set	VFL6
75 mm	Flange Set	VFL7
90 mm	Flange Set	VFL9
110 mm	Flange Set	VFL10
160 mm	Flange Set	VFL16
200 mm	Flange Set	VFL20
250 mm	Flange Set	VFL25

### BUTT WELDING

315 mm	Flange Set	VFL315B
--------	------------	---------

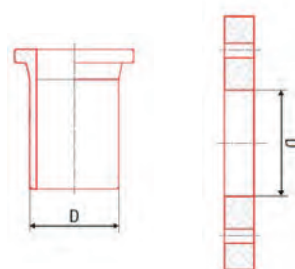

# ELECTROFUSION FITTINGS

## 1.) Equal Socket (Electrofusion)

Size (D)	Description	CODE
63mm	Equal Socket (Electrofusion)	VS6EF
75mm	Equal Socket (Electrofusion)	VS7EF
90mm	Equal Socket (Electrofusion)	VS9EF
110mm	Equal Socket (Electrofusion)	VS10EF
160mm	Equal Socket (Electrofusion)	VS16EF
200mm	Equal Socket (Electrofusion)	VS20EF
250mm	Equal Socket (Electrofusion)	VS25EF
315mm	Equal Socket (Electrofusion)	VS315EF

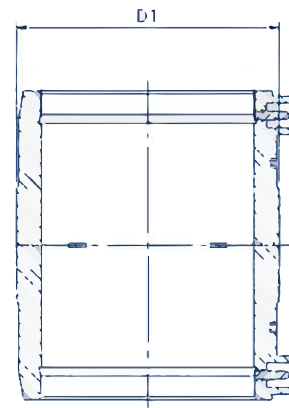

## 2.) Reducer Socket (Electrofusion)

Size (D1,D2)	Description	CODE
200/160mm	Reducer Socket (Electrofusion)	VRS2016EF
250/200mm	Reducer Socket (Electrofusion)	VRS2520EF
315/250mm	Reducer Socket (Electrofusion)	VRS31525EF

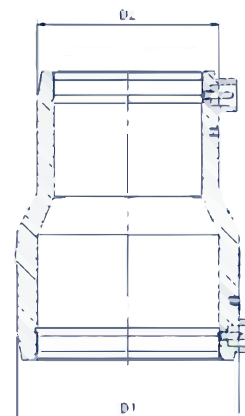

### 3.) Elbow 90° (Electrofusion)

Size (D)	Description	CODE
63 mm	Elbow 90° (Electrofusion)	VE690EF
75 mm	Elbow 90° (Electrofusion)	VE790EF
90 mm	Elbow 90° (Electrofusion)	VE990EF
110 mm	Elbow 90° (Electrofusion)	VE1090EF
160 mm	Elbow 90° (Electrofusion)	VE1690EF
200 mm	Elbow 90° (Electrofusion)	VE2090EF
250 mm	Elbow 90° (Electrofusion)	VE2590EF

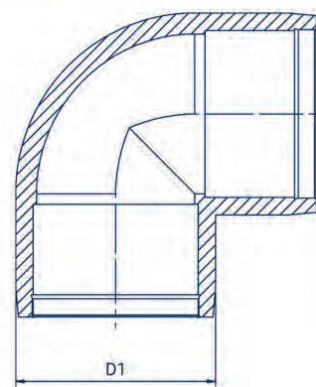

### 4.) Elbow 45° (Electrofusion)

Size (D)	Description	CODE
63 mm	Elbow 45° (Electrofusion)	VE645EF
75 mm	Elbow 45° (Electrofusion)	VE745EF
90 mm	Elbow 45° (Electrofusion)	VE945EF
110 mm	Elbow 45° (Electrofusion)	VE1045EF
160 mm	Elbow 45° (Electrofusion)	VE1645EF
200 mm	Elbow 45° (Electrofusion)	VE2045EF
250 mm	Elbow 45° (Electrofusion)	VE2545EF

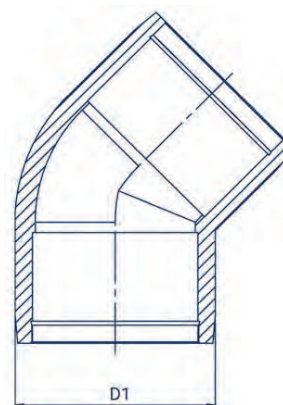



## 5.) Equal Tee (Electrofusion)

Size (D1,D2)	Description	CODE
63x63x63 mm	Elbow 90° (Electrofusion)	VE690EF
75x75x75 mm	Elbow 90° (Electrofusion)	VE790EF
90x90x90 mm	Elbow 90° (Electrofusion)	VE990EF
110x110x110 mm	Elbow 90° (Electrofusion)	VE1090EF
160x160x160 mm	Elbow 90° (Electrofusion)	VE1690EF
200x200x200 mm	Elbow 90° (Electrofusion)	VE2090EF
250x250x250 mm	Elbow 90° (Electrofusion)	VE2590EF

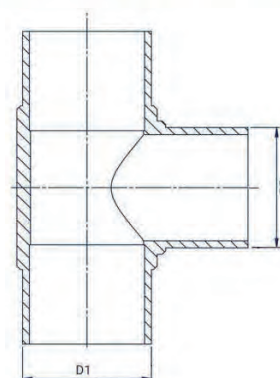

## 6.) Flange Set (Electrofusion)

Size (D)	Description	CODE
63 mm	Flange Set (Electrofusion)	VFL6EF
75 mm	Flange Set (Electrofusion)	VFL7EF
90 mm	Flange Set (Electrofusion)	VFL9EF
110 mm	Flange Set (Electrofusion)	VFL10EF
160 mm	Flange Set (Electrofusion)	VFL16EF
200 mm	Flange Set (Electrofusion)	VFL20EF
250 mm	Flange Set (Electrofusion)	VFL25EF

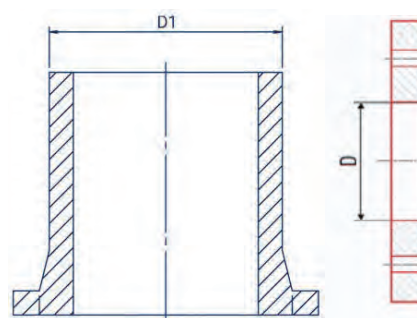

# TOOLS AND EQUIPMENTS

## 1.) Welding Socket

To connect pipes to valves, fittings, or other pipe sections, it is recommended to use fillet-type seal welds. Socket welded joints construction is an excellent choice, especially when high leakage integrity and exceptional structural strength are critical design considerations.



Size (D)	Description	CODE
63mm	Welding Socket	VWS6
75mm	Welding Socket	VWS7
90mm	Welding Socket	VWS9
110mm	Welding Socket	VWS10
160mm	Welding Socket	VWS16

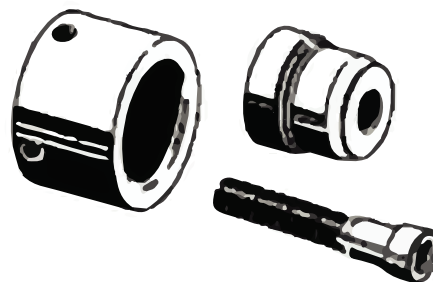

## 2.) Pipe Cutter

A pipe cutter is a type of tool used by plumber to cut pipes. Besides producing a clean cut, the tool is often a faster, cleaner, and more convenient way of cutting pipe.



Size (D)	Description	CODE
16-40 mm	Pipe Cuter	PC
50-160mm	Special Pipe Cuter	SPC

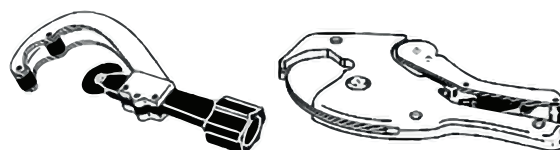

## 3.) Welding Machine Set

Our PP-Rc Pipe Welding Machine is designed for welding PP-Rc pipes and fittings. It features a high-quality PTFE non-stick coating, ensuring smooth and efficient welding operations.

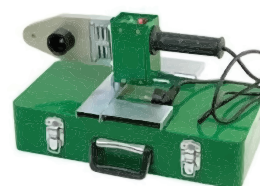

Size (D)	Description	CODE
20-32 mm	Welding Machine	VWMB
40-110mm	Welding Machine	VSWM



#### 4.) Peeling Machine for Electrofusion

The peelers are used for shaving a thin layer of material off the outside diameter of the oxidized pipe surface. Thus preparing the pipe for a clean weld and creating a good interference fit from pipe to fitting.

Size (D)	Description	CODE
63-315 mm	Peeling Machine	VPM63315



#### 5.) Adjustable Welding Machine Set

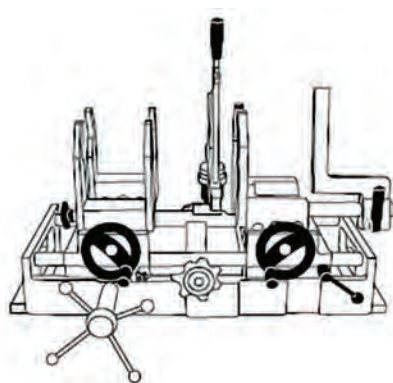

Our PP-Rc Pipe Welding Machine is specifically designed for welding PP-Rc pipes and fittings. It is equipped with a high-quality PTFE non-stick coating, ensuring smooth and efficient welding operations.

Size (D)	Description	CODE
110-200 mm	Welding Machine	VBSWM



#### 6.) Level Stand

A PPR pipe level stand is typically a support system used to maintain the correct alignment and level of the PPR pipes during installation. It is especially helpful when installing long runs of piping to ensure proper slop (if necessary) and prevent any sagging or misalignment that could affect the system's performance.



Size (D)	Description	CODE
63-315 mm	Level Stand	VLS63315

## 7.) Electrofusion Machine

An Electro Fusion Machine is used for welding and joining PPR (Polypropylene Random Copolymer) and other types of plastic pipes and fittings through the electro-fusion process. This process involves the use of an electrofusion fitting, which contains built-in heating elements that are activated by the electro-fusion machine to melt the pipe and fitting surfaces, allowing them to fuse together securely.



Size (D)	Description	CODE
63-315mm	Electro fusion Machine	VEFM63315

## 8.) Electrical Pipe Cutter

An electrical pipe cutter is a power tool used to quickly and efficiently cut various types of pipes, including PPR (Polypropylene Random Copolymer). It uses an electric motor to drive a cutting mechanism, such as a rotary blade or cutting wheel, making it faster and more precise than manual cutting tools. Electrical pipe cutters are widely used in plumbing, construction, and industrial applications where high-volume, accurate cutting is necessary.



Size (D)	Description	CODE
63-315 mm	Electrical Pipe Cutter	VEPC63315

## FREQUENTLY ASKED QUESTIONS

### Q: Which is the raw material used to produce VIALLI PP-Rc Pipe system?

**A:** PP-Rc pipe systems are produced from a type of polypropylene known as polypropylene random copolymer, often referred to as Type III PP-Rc (commonly known as PPR). This raw material is obtained through the cracking of petroleum, where propane-monomer polymerizes with polypropylene co-monomer to form polypropylene random copolymer. We exclusively utilize one of the best PP-Rc raw materials globally, approved for the production of pipes and fittings in accordance with DIN 8078 and DIN 16962 standards.

### Q: How are the Pipes and Fittings manufactured using this raw material?

**A:** The PP-Rc raw material is a thermoplastic resin supplied in pre-colored granules. This raw material is transformed into finished products by raising the temperature, which plasticizes the material. This process allows the production of pipes through extrusion and fittings through molding.

### Q: Is insulation necessary for hot water applications?

**A:** Normally, it is not mandatory for plumbers to install insulation because the thermal conductivity of PP-Rc piping systems is lower compared to metal piping systems (0.24 W/mK). However, for centralized heating systems, where preventing heat loss and isolating pipelines from other utilities is important, it is advisable to insulate these lines. The required thickness of insulation is significantly lower compared to conventional lines due to the inherent properties of PP-Rc piping systems.

### Q: What do PP-Rc type 1 Type, Type 2 and Type 3 refer to? What are the difference between them?

**A:** Plastic pipes have become more resistant as they have evolved. The first produced polypropylene had a structure consisting of propylene molecules, which was referred to as Type 1 Polypropylene homo-polymer. Later, propylene molecules with mixed sequences were introduced alongside the propylene molecules, leading to what is known as Type 2 Polypropylene block copolymer. Subsequently, the Type 3 product was developed, which includes ethylene molecules regularly sequenced among the propylene molecules.

Today, due to their specific characteristics, Type 2 and Type 3 are widely used. Type 2 is employed primarily in cold water networks and is not suitable for use with hot fluids. On the other hand, Type 3 can be used for hot water systems because it offers resistance to hot fluids.

### Q: Are VIALLI pipes UV resistant?

**A:** VIALLI PP-Rc pipes and fittings possess adequate UV stability to protect them from UV rays. Nevertheless, it is not advisable to continuously expose these pipes and fittings to direct sunlight for outdoor pipeline installations. It is recommended to apply an acrylic paint coating to the pipes or to shield them from direct sunlight by providing a protective covering or installing them in a duct. This precaution helps extend the lifespan and maintain the performance of the pipes and fittings when used outdoors.

### Q: What is DIN Standards?

**A:** The Deutsches Institut für Normung (DIN) is Germany's institute for standardization. It is a technical and scientific association recognized by the German government as the national standards body representing Germany's interests at international and European levels. DIN provides a forum in which representatives from manufacturing industries, consumer organizations, commerce, the trades, service industries, science and technical inspectorates, and government can discuss and define their specific standardization requirements, recording the results as German Standards.

### Q: What are production standards of VIALLI PP-Rc ?

Following standards are used for the production of VIALLI pipes and fittings:

Standard	Concern Production
DIN 8076	Standard for testing metal threaded joints
DIN 8077	Polypropylene pipes. dimensions
DIN 8078	Polypropylene pipes, general quality requirements & testing
DIN 16962	Pipe joints and elements for polypropylene pressure pipes
DIN 1988	Drinking water supply systems, materials, components, Appliances Design and installation
DIN 16928	Pipe joints & elements for pipes, laying-general directions
DIN 2999	Standard for fittings with threaded metallic insert
EN ISO -15874	Plastic piping system for hot & cold water Installation – (PP)
BS 6700	Design, installation, testing and maintenance of services supplying water for domestic use with in buildings and their cartilages
DVS 2207	Welding of thermoplastics
DVS 2208	Welding machines and devices for thermoplastics

### Q: How can we connect VIALLI products to other metal systems?

**A:** VIALLI PP-Rc system can be connected to other metal systems easily by a flange or a metal adaptor. (BS 6920).

### Q: What is the service life (life span) of VIALLI PP-Rc piping systems for different pressure groups?

**A:** P-RC pipes have a service life of 50 years according to DIN Standards for in house applications. To have detailed information for Different temperatures and pressure rates, please refer product catalogue.

### Q: Are VIALLI PP-Rc pipes used for drinking water? Are they Hygienic/Healthy?

**A:** PP-Rc products can safely be used for Drinking water. VAILLI PP-Rc products have got all international Approvals as well as the approvals of the sales territories.

### Q: What does PN Stands for and what does it mean to be PN-16 or PN-20?

**A:** PN stands for Nominal Pressure, it is numerical designation used for reference purpose related to mechanical characteristics of the component of a piping system. A PN-20 pipe mean the pipe can withstand pressure Up to 20 Bars.

**Q: Why is VIALLI fittings categorized under PN-25 Types?**

**A:** VIALLI fittings can withstand temperature above 95°C and pressure up to 25 kg/ cm<sup>2</sup>, (25 Bars) hence categorized under PN-25.

**Q: What does PN Stands for and what does it mean to be PN-16 or PN-20?**

**A:** PN stands for Nominal Pressure, it is numerical designation used for reference purpose related to mechanical characteristics of the component of a piping system. A PN-20 pipe mean the pipe can withstand pressure Up to 20 Bars.

**Q: What is the difference between PN-16 and PN-20 pipes due to the application areas?**

**A:** Life Span of PN20 is Longer than PN-16 pipes under the same temperature and pressure conditions. Especially for the exposed installations as the expansion of PN-20 pipes are 1/5 of PN 16 pipes sagging and snaking problems are avoided.

**Q: How is pipe categorized as PN-10, PN-16, PN-20 & PN-25 matched with SDR (Standard Dimension Rate) of conventional pipes?**

**A:** PP-Rc Pipes with all thickness of OD/SDR is matched as the Equivalent PP-Rc Pipe for a SDR Pipe.

PN-10 is regarded as equivalent to SDR 11 Because, PN 10 Pipe of 20 mm OD has thickness approx. to  $20/11=1.8$

PN-10 160 mm has thickness approx. to  $160/11=14.55$   
Likewise SDR 7.4 is matched as PN-16 and SDR 6 as PN-20.

**Q: Can the pipes alignment be adjusted after the welding process?**

**A:** Alignment up to 5 degree relative to the axis of the pipe can be done immediately after jointing.

**Q: What is the intended use of different classes of Pipes?**

**A:** PN 10 – Cold water distribution and floor heating systems  
 PN 16-Higher pressure cold water distribution and domestic hot water system at lower pressures.  
 PN 20-Hot water distribution Central  
 PN 25-Higher pressure Hot water distribution Central and Domestic

**Q: What should be done is somebody accidentally drills a hole on the pipe?**

**A:** If it is a nail or a drill hole (10.5mm deep max) you may use “VIALLI PP-Rc hole repair kit” to repair the hole on the pipe. If the damage part of the pipe is not concealed yet (before the pressure test is conducted), the recommended procedure is to cut that part and replace it by a new part through normal welding of a socket.

**Q: Should any precaution be taken for the installation at low temperatures?**

**A:** At lower temperature of 0°C and below, the flexibility of PP-Rc pipes reduces and impact strength also reduces. This makes pipes more prone to mechanical damages against impact loads. To avoid the damages at low temperature, it is advisable to insulate the pipe lines

### Q: Do VIALLI PP-Rc Piping systems burn?

**A:** VIALLI pipes and fittings have a combustion point of 330°C and a burning point of 360°C. These properties conform to the B2 (Normally inflammable) class fire requirements for normal combustibility according to DIN 4102. In the event of a fire, PP-Rc pipes and fittings emit carbon dioxide and water. Additionally, depending on the availability of oxygen, small amounts of carbon monoxide gas, molecular hydrocarbons, and oxidation products may also be emitted. Even in cases of incomplete combustion, the materials emitted are less toxic than those from wood or conventional pipe systems under similar conditions.

### Q: How can the PP-Rc pipes & fittings joined together?

**A:** The process of joining PP-Rc pipes and fittings is very simple and results in inseparable water joints. This is achieved using a straightforward welding machine that melts the internal surface of the fittings and the external surface of the pipe at 270°C, allowing the material of the pipe and the fitting to meld together. Because both the pipes and fittings are produced from the same material, the connection is typically homogeneous.

### Q: How is the pipe cutting recommended?

**A:** It is advised to use sharp cutting tools to cut the pipe with no burrs, VIALLI provides cutting tools of size 20-40, 20-63, 50-110, 160, 200 & 250.

### Q: How is the size of pipes and fittings measured?

**A:** Pipes size is measured by mm (millimeter) of its outer Dia. PRR fittings are measured by mm (millimeter) of inner dia. and metal threaded fittings threaded side size is measured in inches.

### Q: Which is the metal used in manufacturing of VIALLI Threaded fittings?

**A:** VIALLI Threaded fittings are manufactured using stainless steel inserts, tin bronze inserts, brass with nickel plated inserts & natural brass inserts and its threading is made as per British Standard Threading.

### Q: How can the stressing of pipe be avoided?

**A:** Possible linear thermal expansion/contraction needs to be taken into consideration during designing and installing. Stressing of pipes can be avoided by providing flexible free length and proper supporting.

### Q: Why is joining of pipes without using sockets un-recommended?

**A:** This joining results in blockage or reduction in inner Dia. At joining point hence it's recommended to avoid as it can affect the function of the system.



**Q: Is joining of pipes & fittings using glue recommended?**

**A:** Using glue connections is not recommended as they cannot provide a 50-year guarantee against leakages. Additionally, glue connections are susceptible to issues like termite attacks and frequent maintenance requirements, which can impact the hygienic and long-term performance of the VIALLI PP-Rc Pipe system.

**Q: How is pressure testing recommended?**

**A:** Before any pipes are filled or cemented in concealed applications, they must undergo hydrostatic testing to check for pressure loss or leaks. The testing involves pressurizing the closed system, with all ends sealed using caps and pipe plugs, with water up to 25 bar for PN-20 and PN-25 pipes, and up to 15 bar for PN-16 pipes, all at room temperature. The pressure should be maintained for at least 8 hours to detect any pressure drop. This process is repeated to confirm the absence of even minor leaks. If a significant pressure drop is observed, the specific area of leakage must be identified and rectified.

# TECHNICAL SUPPORT

## Training Services

---

Technical training ensures that client are proficient in using complex tools, machinery, or software while adhering to safety standards and best practices.



## Safety and Compliance Training

---

To teach clients to recognize and mitigate risks in their work environments, ensuring safety and compliance with local regulations.



## Quality

---

Our product is made using the finest raw materials and undergoes rigorous quality control to ensure it meets the highest standards. We are committed to delivering not only great performance but also long-term reliability, so you can trust that it will meet your expectations and serve you well for years to come.



# CONTACTS

## Technical Contact

---

Website: [vialligmbh.de](http://vialligmbh.de)  
 Email: [info@vialligmbh.de](mailto:info@vialligmbh.de)  
 Tel: +49 173 4674615



## Location

---

Gewerbegebiet Derching, Egerländer Str. 16, 86316 Friedberg, Germany



[www.vialligmbh.de](http://www.vialligmbh.de)  
Egerländer Str. 16, Industriegebiet Derching,  
Friedberg, Bayern, 86316, Germany.  
Email - [info@villigmbh.de](mailto:info@villigmbh.de)  
Tel - +49 173 4674615

**VIALLI<sup>®</sup>** **GERMANY** **GmbH**